

A large, abstract graphic composed of various shades of red. It features curved, overlapping shapes that create a sense of depth and movement. The year '2020' is printed in a light, semi-transparent white font in the lower right quadrant of this graphic.

2020

Accessories for shelves



Accessories for shelves	Аксессуары к торговым полкам	
For perforated shelves	Для перфорированных полок	
Wire front	Передние ограничители	04
Wire lateral	Боковые ограничители	12
Wire average	Средние ограничители	13
Dividers	Разделители	14
For shelves	Для неперфорированных полок	
Wire front	Передние ограничители	17
Dividers	Разделители	20
Hooks and hanged elements	Крюки и навесные элементы	
Bar	Балки	24
Separator	Сепараторы	25
Hooks	Крюки	27
Hangers	Вешалки	28
Hooks for sport goods	Крюки для спорт товаров	31
Hooks for household accessories	Бытовые аксессуары	32
Holders for manual tools	Держатели для ручных инструментов	35
Support for ware	Подставки для посуды	39
Dividers	Разделители	40
Clothes frame	Подвески	42
Hooks for perforated bar	Крюки для перфорированной балки	43
Hooks for perforated back panel	Крюки на перфорированную заднюю панель	45
Hangers for	Вешалки на эконом панель	47
Hooks for	Крюки на эконом панель	48
Household accessories for shelves	Бытовые аксессуары на полку	50
Price strips	Ценникодержатели	51

Передний ограничитель полки H=30 | Wire front for shelf H=30

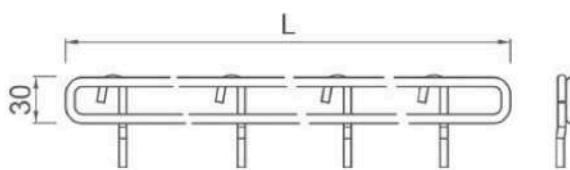

L, mm	Color	It.№	L, mm	Color	It.№	L, mm	Color	It.№	L, mm	Color	It.№
660	RAL	KI042000	1000	RAL	KI0422001	1250	RAL	KI0422002	1330	RAL	KI042003
660	zinc	ZN042000	1000	zinc	ZN0422001	1250	zinc	ZN0422002	1330	zinc	ZN042003
660	chrome	CH042000	1000	chrome	CH0422001	1250	chrome	CH0422002	1330	chrome	CH042003

Передний ограничитель полки H=60 | Wire front for shelf H=60

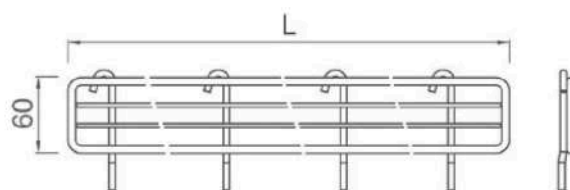

L, mm	Color	It.№	L, mm	Color	It.№	L, mm	Color	It.№	L, mm	Color	It.№
660	RAL	KI042004	1000	RAL	KI0422005	1250	RAL	KI0422006	1330	RAL	KI042007
660	zinc	ZN042004	1000	zinc	ZN0422005	1250	zinc	ZN0422006	1330	zinc	ZN042007
660	chrome	CH042004	1000	chrome	CH0422005	1250	chrome	CH0422006	1330	chrome	CH042007

Передний ограничитель полки H=90 | Wire front for shelf H=90

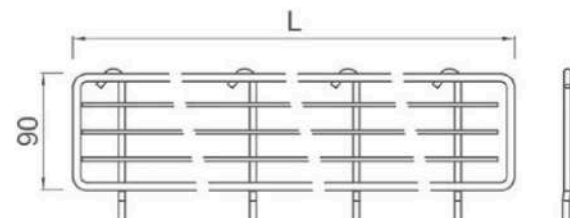
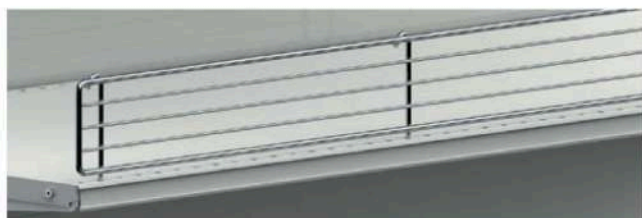

Color	L, mm	It.№	L, mm	It.№	L, mm	It.№	L, mm	It.№
RAL	660	KI042008	1000	KI0422009	1250	KI0422010	1330	KI0420011
zinc	660	ZN042008	1000	ZN0422009	1250	ZN0422010	1330	ZN042011
chrome	660	CH042008	1000	CH0422009	1250	CH0422010	1330	CH042011

Передний ограничитель полки H=125 | Wire front for shelf H=125

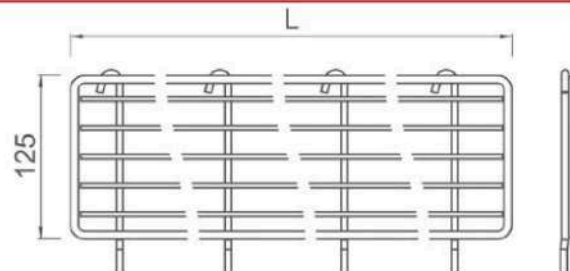
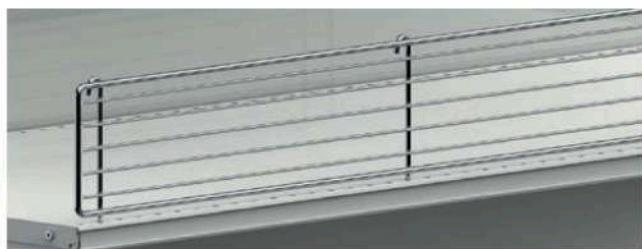

Color	L, mm	It.№	L, mm	It.№	L, mm	It.№	L, mm	It.№
RAL	660	KI042276	1000	KI042277	1250	KI042278	1330	KI042279
zinc	660	ZN042276	1000	ZN042277	1250	ZN042278	1330	ZN042279
chrome	660	CH042276	1000	CH042277	1250	CH042278	1330	CH042279

Передний ограничитель полки H=160 | Wire front for shelf H=160

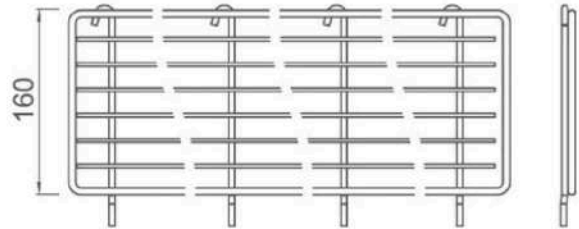

L, mm	Color	It.№	L, mm	Color	It.№	L, mm	Color	It.№	L, mm	Color	It.№
660	RAL	KI042280	1000	RAL	KI042281	1250	RAL	KI042282	1330	RAL	KI042283
660	zinc	ZN042280	1000	zinc	ZN042281	1250	zinc	ZN042282	1330	zinc	ZN042283
660	chrome	CH042280	1000	chrome	CH042281	1250	chrome	CH042282	1330	chrome	CH042283

Передний ограничитель полки H=30 ВУ90 | Wire front H=30 for shelf internal corner 90

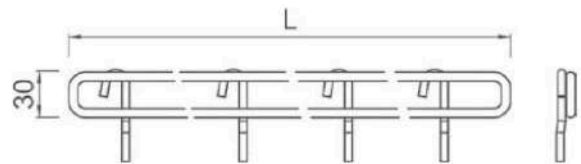

K, mm	L, mm	Panel, mm	Color	It.№	K, mm	L, mm	Panel, mm	Color	Art.
300	574	1000	RAL	KI042180	400	433	1000	RAL	KI042181
300	574	1000	zinc	ZN042180	400	433	1000	zinc	ZN042181
300	574	1000	chrome	CH042180	400	433	1000	chrome	CH042181
500	290	1000	RAL	KI042182	500	620	1330	RAL	KI042184
500	290	1000	zinc	ZN042182	500	620	1330	zinc	ZN042184
500	290	1000	chrome	CH042182	500	620	1330	chrome	CH042184
600	150	1000	RAL	KI042183	600	480	1330	RAL	KI042185
600	150	1000	zinc	ZN042183	600	480	1330	zinc	ZN042184
600	150	1000	chrome	CH042183	600	480	1330	chrome	CH042184
700	338	1330	RAL	KI042186	700	197	1330	RAL	KI042187
700	338	1330	zinc	ZN042186	700	197	1330	zinc	ZN042187
700	338	1330	chrome	CH042186	700	197	1330	chrome	CH042187

Передний ограничитель полки ВУ90 Н=60 | Wire front H=60 for shelf internal corner 90

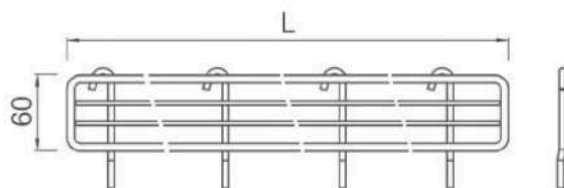

K, mm	L, mm	Panel, mm	Color	It.№	K, mm	L, mm	Panel, mm	Color	It.№
300	574	1000	RAL	KI042194	400	433	1000	RAL	KI042195
300	574	1000	zinc	ZN042194	400	433	1000	zinc	ZN042195
300	574	1000	chrome	CH042194	400	433	1000	chrome	CH042195
500	290	1000	RAL	KI042196	500	620	1330	RAL	KI042198
500	290	1000	zinc	ZN042196	500	620	1330	zinc	ZN042198
500	290	1000	chrome	CH042196	500	620	1330	chrome	CH042198
600	150	1000	RAL	KI042197	600	480	1330	RAL	KI042199
600	150	1000	zinc	ZN042197	600	480	1330	zinc	ZN042199
600	150	1000	chrome	CH042197	600	480	1330	chrome	CH042199
700	338	1330	RAL	KI042200	700	197	1330	RAL	KI042201
700	338	1330	zinc	ZN042200	700	197	1330	zinc	ZN042201
700	338	1330	chrome	CH042200	700	197	1330	chrome	CH042201

Передний ограничитель ВУ90 полки Н=90 | Wire front H=90 for shelf internal corner 90

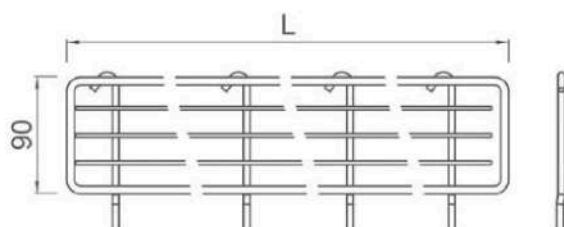

K, mm	L, mm	Panel, mm	Color	It.№	K, mm	L, mm	Panel, mm	Color	It.№
300	574	1000	RAL	KI042208	400	433	1000	RAL	KI042209
300	574	1000	zinc	ZN042208	400	433	1000	zinc	ZN042209
300	574	1000	chrome	CH042208	400	433	1000	chrome	CH042209
500	290	1000	RAL	KI042210	500	620	1330	RAL	KI042212
500	290	1000	zinc	ZN042210	500	620	1330	zinc	ZN042212
500	290	1000	chrome	CH042210	500	620	1330	chrome	CH042212
600	150	1000	RAL	KI042211	600	480	1330	RAL	KI042213
600	150	1000	zinc	ZN042211	600	480	1330	zinc	ZN042213
600	150	1000	chrome	CH042211	600	480	1330	chrome	CH042213
700	338	1330	RAL	KI042214	700	197	1330	RAL	KI042215
700	338	1330	zinc	ZN042214	700	197	1330	zinc	ZN042215
700	338	1330	chrome	CH042214	700	197	1330	chrome	CH042215

Передний ограничитель H=30 полки НУ90 | Wire front H=30 for shelf external corner 90

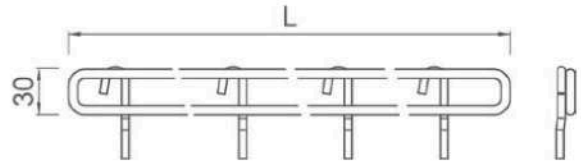

K, mm	L, mm	Panel, mm	Color	It.№	K, mm	L, mm	Panel, mm	Color	It.№
300	574	1000	RAL	KI042194	400	433	1000	RAL	KI042195
300	574	1000	zinc	ZN042194	400	433	1000	zinc	ZN042195
300	574	1000	chrome	CH042194	400	433	1000	chrome	CH042195
500	290	1000	RAL	KI042196	500	620	1330	RAL	KI042198
500	290	1000	zinc	ZN042196	500	620	1330	zinc	ZN042198
500	290	1000	chrome	CH042196	500	620	1330	chrome	CH042198
600	150	1000	RAL	KI042197	600	480	1330	RAL	KI042199
600	150	1000	zinc	ZN042197	600	480	1330	zinc	ZN042199
600	150	1000	chrome	CH042197	600	480	1330	chrome	CH042199
700	338	1330	RAL	KI042200	700	197	1330	RAL	KI042201
700	338	1330	zinc	ZN042200	700	197	1330	zinc	ZN042201
700	338	1330	chrome	CH042200	700	197	1330	chrome	CH042201

Передний ограничитель H=60 полки НУ90 | Wire front H=60 for shelf external corner 90

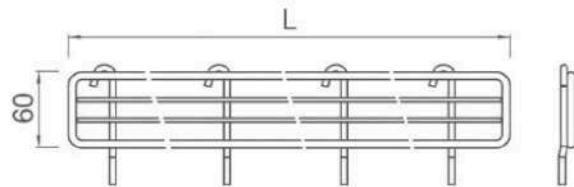

K, mm	L, mm	Color	It.№	K, mm	L, mm	Color	It.№
300	628	RAL	KI42203	400	770	RAL	KI042203
300	628	zinc	ZN042203	400	770	zinc	ZN042203
300	628	chrome	CH042202	400	770	chrome	CH042203
500	910	RAL	KI042204	600	1050	RAL	KI042205
500	910	zinc	ZN042204	600	1050	zinc	ZN042205
500	910	chrome	CH042204	600	1050	chrome	CH042205
700	1193	RAL	KI042206	800	1335	RAL	KI042203
700	1193	zinc	ZN042206	800	1335	zinc	ZN042203
700	1193	chrome	CH042206	800	1335	chrome	CH042207

Передний ограничитель H=90 полки НУ90 | Wire front H=90 for shelf external corner 90



K, mm	L, mm	Color	It.№	K, mm	L, mm	Color	It.№
300	628	RAL	KI042216	300	628	RAL	KI042217
300	628	zinc	ZN042216	300	628	zinc	KI042217
300	628	chrome	CH042216	300	628	chrome	KI042217
500	910	RAL	KI042218	500	910	RAL	KI042219
500	910	zinc	ZN042218	500	910	zinc	KI042219
500	910	chrome	CH042218	500	910	chrome	KI042219
700	1193	RAL	KI042220	700	1193	RAL	KI042221
700	1193	zinc	ZN042220	700	1193	zinc	KI042221
700	1193	chrome	CH042220	700	1193	chrome	KI042221

Передний ограничитель H=30 полки ВУ45 | Wire front H=30 for shelf internal corner 45

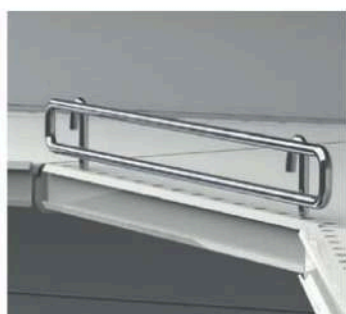

K, mm	L, mm	Color	It.№	K, mm	L, mm	Color	It.№
300	423	RAL	KI042322	400	346	RAL	KI042323
300	423	zinc	ZN042322	400	346	zinc	ZN042323
300	423	chrome	CH042322	400	346	chrome	CH042323
500	270	RAL	KI042324	600	192	RAL	KI042325
500	270	zinc	ZN042324	600	192	zinc	ZN042325
500	270	chrome	CH042324	600	192	chrome	CH042325
700	456	RAL	KI042326	800	379	RAL	KI042327
700	456	zinc	ZN042326	800	379	zinc	ZN042327
700	456	chrome	CH042326	800	379	chrome	CH042327

Передний ограничитель H=60 полки ВУ45 | Wire front H=60 for shelf internal corner 45



K, mm	L, mm	Color	It.№	K, mm	L, mm	Color	It.№
300	423	RAL	KI042328	400	346	RAL	KI042329
300	423	zinc	ZN042328	400	346	zinc	ZN042329
300	423	chrome	CH042328	400	346	chrome	CH042329
500	270	RAL	KI042330	600	192	RAL	KI042331
500	270	zinc	ZN042330	600	192	zinc	ZN042331
500	270	chrome	CH042330	600	192	chrome	CH042331
700	456	RAL	KI042332	800	379	RAL	KI042333
700	456	zinc	ZN042332	800	379	zinc	ZN042333
700	456	chrome	CH042332	800	379	chrome	CH042333

Передний ограничитель H=90 полки ВУ45 | Wire front H=90 for shelf internal corner 45

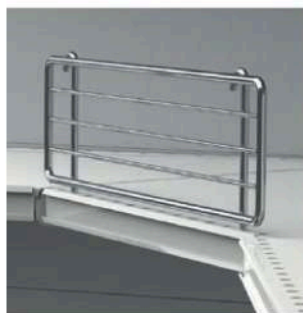

K, mm	L, mm	Color	It.№	K, mm	L, mm	Color	It.№
300	423	RAL	KI042334	400	346	RAL	KI042335
300	423	zinc	ZN042334	400	346	zinc	ZN042335
300	423	chrome	CH042334	400	346	chrome	CH042335
500	270	RAL	KI042336	600	192	RAL	KI042337
500	270	zinc	ZN042336	600	192	zinc	ZN042337
500	270	chrome	CH042336	600	192	chrome	CH042337
500	456	RAL	KI042338	800	379	RAL	KI042339
500	456	zinc	ZN042338	800	379	zinc	ZN042339
500	456	chrome	CH042338	800	379	chrome	CH042339

Передний ограничитель H=30 полки НУ45 | Wire front H=30 for shelf external corner 45



K, mm	L, mm	Color	It.№	K, mm	L, mm	Color	It.№
300	438	RAL	KI042340	400	514	RAL	KI042341
300	438	zinc	ZN042340	400	514	zinc	ZN042321
300	438	chrome	CH042340	400	514	chrome	CH042341
500	591	RAL	KI042342	600	667	RAL	KI042343
500	591	zinc	ZN042342	600	667	zinc	ZN042343
500	591	chrome	CH042342	600	667	chrome	CH042343
700	744	RAL	KI042344	800	820	RAL	KI042345
700	744	zinc	ZN042344	800	820	zinc	ZN042345
700	744	chrome	CH042344	800	820	chrome	CH042345

Передний ограничитель H=60 полки НУ45 | Wire front H=60 for shelf external corner 45



K, mm	L, mm	Color	It.№	K, mm	L, mm	Color	It.№
300	438	RAL	KI042346	400	514	RAL	KI042347
300	438	zinc	ZN042346	400	514	zinc	ZN042347
300	438	chrome	CH042346	400	514	chrome	CH042347
500	591	RAL	KI042348	600	667	RAL	KI042349
500	591	zinc	ZN042348	600	667	zinc	ZN042349
500	591	chrome	CH042348	600	667	chrome	CH042349
700	744	RAL	KI042350	800	820	RAL	KI042351
700	744	zinc	ZN042350	800	820	zinc	ZN042351
700	744	chrome	CH042350	800	820	chrome	CH042351

Передний ограничитель H=90 полки НУ45 | Wire front H=90 for shelf external corner 45



K, mm	L, mm	Color	It.№	K, mm	L, mm	Color	It.№
300	438	RAL	KI042352	400	514	RAL	KI042353
300	438	zinc	ZN042352	400	514	zinc	ZN042353
300	438	chrome	CH042352	400	514	chrome	CH042353
500	591	RAL	KI042354	600	667	RAL	KI042355
500	591	zinc	ZN042354	600	667	zinc	ZN042355
500	591	chrome	CH042354	600	667	chrome	CH042355
700	744	RAL	KI042356	800	820	RAL	KI042357
700	744	zinc	ZN042356	800	820	zinc	ZN042357
700	744	chrome	CH042356	800	820	chrome	CH042357

Передний ограничитель торцевой полки H=30 | Wire front for end shelf H=30

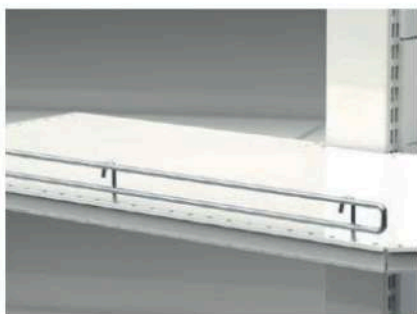

K, mm	L, mm	Color	It.№	K, mm	L, mm	Color	It.№
300	532	RAL	KI042222	400	684	RAL	KI042225
300	532	zinc	ZN042222	400	684	zinc	ZN042225
300	532	chrome	CH042222	400	684	chrome	CH042225
500	834	RAL	KI042228	600	986	RAL	KI042231
500	834	zinc	ZN042228	600	986	zinc	ZN042231
500	834	chrome	CH042228	600	986	chrome	CH042231

Передний ограничитель торцевой полки H=60 | Wire front for end shelf H=60

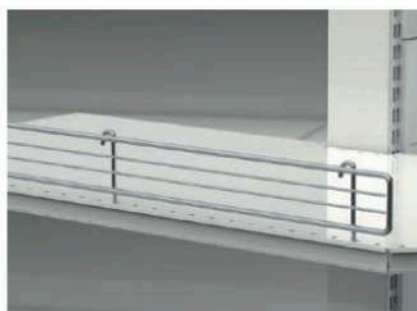

K, mm	L, mm	Color	It.№	K, mm	L, mm	Color	It.№
300	532	RAL	KI042234	400	684	RAL	KI042237
300	532	zinc	ZN042234	400	684	zinc	ZN042237
300	532	chrome	CH042234	400	684	chrome	CH042237
500	834	RAL	KI042240	600	986	RAL	KI042243
500	834	zinc	ZN042240	600	986	zinc	ZN042243
500	834	chrome	CH042240	600	986	chrome	CH042243

Передний ограничитель торцевой полки H=90 | Wire front for end shelf H=90



K, mm	L, mm	Color	It.№	K, mm	L, mm	Color	It.№
300	532	RAL	KI042246	400	684	RAL	KI042249
300	532	zinc	ZN042246	400	684	zinc	ZN042249
300	532	chrome	CH042246	400	684	chrome	CH042249
500	834	RAL	KI042252	600	986	RAL	KI042255
500	834	zinc	ZN042252	600	986	zinc	ZN042255
500	834	chrome	CH042252	600	986	chrome	CH042255

Передний ограничитель полукруглой полки H=30 | Wire front for rounded shelf H=30

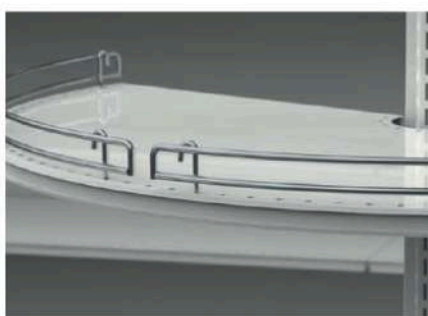

Shelf, mm	L, mm	Color	It.№	Shelf, mm	L, mm	Color	It.№
R300	704,6	RAL	KI040177	R400	635,4	RAL	KI040178
R300	704,6	zinc	ZN040177	R400	635,4	zinc	ZN040178
R300	704,6	chrome	CH040177	R400	635,4	chrome	CH040178
R500	776,3	RAL	KI040179	R600	918,6	RAL	KI040180
R500	776,3	zinc	ZN040179	R600	918,6	zinc	ZN040180
R500	776,3	chrome	CH040179	R600	918,6	chrome	CH040180

Передние ограничители полукруглой полки H=60 | Wire front for rounded shelf H=60

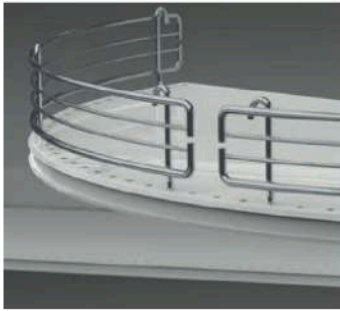

Shelf, mm	L, mm	Color	It.№	Shelf, mm	L, mm	Color	It.№
R300	704.6	RAL	KI040181	R400	635.4	RAL	KI040182
R300	704.6	zinc	ZN040181	R400	635.4	zinc	ZN040182
R300	704.6	chrome	CH040181	R400	635.4	chrome	CH040182
R500	776.3	RAL	KI040083	R600	918.6	RAL	KI040184
R500	776.3	zinc	ZN040183	R600	918.6	zinc	ZN040184
R500	776.3	chrome	CH040183	R600	918.6	chrome	CH040184

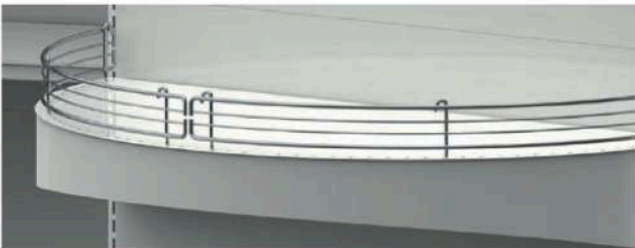

Shelf, mm	L, mm	Color	It.№
L1000	687	RAL	KI042260
L1000	687	zinc	ZN042260
L1000	687	chrome	CH042260
L1250	867	RAL	KI042263
L1250	867	zinc	ZN042263
L1250	867	chrome	CH042263

Передний ограничитель овальной полки H=30 | Wire front for oval shelf H=30



L, mm	Color	It.№	L, mm	Color	It.№
660	RAL	KI042266	1250	RAL	KI042268
660	zinc	ZN042266	1250	zinc	ZN042268
660	chrome	CH042266	1250	chrome	CH042268
1000	RAL	KI042267	1330	RAL	KI042269
1000	zinc	ZN042267	1330	zinc	ZN042269
1000	chrome	CH042267	1330	chrome	CH042269

Передний ограничитель овальной полки H=60 | Wire front for oval shelf H=60

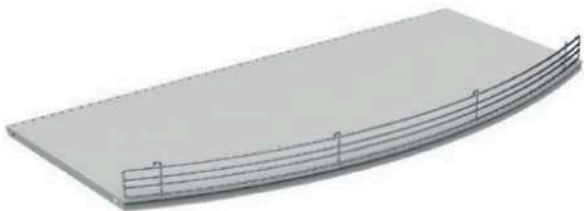

L, mm	Color	It.№	L, mm	Color	It.№
660	RAL	KI042359	1250	RAL	KI042361
660	zinc	ZN042359	1250	zinc	ZN042361
660	chrome	CH042359	1250	chrome	CH042361
1000	RAL	KI042360	1330	RAL	KI042362
1000	zinc	ZN042360	1330	zinc	ZN042362
1000	chrome	CH042360	1330	chrome	CH042362

Боковой ограничитель полки H=30 | Wire lateral for shelf H=30



K, mm	Color	It.№	K, mm	Color	It.№
200	RAL	KI042012	500	RAL	KI042015
200	zinc	ZN042012	500	zinc	ZN042015
200	chrome	CH0420122	500	chrome	CH042015
300	RAL	KI042013	600	RAL	KI042016
300	zinc	ZN042013	600	zinc	ZN042016
300	chrome	CH042013	600	chrome	CH042016
400	RAL	KI042014	700	RAL	KI042017
400	zinc	ZN042014	700	zinc	ZN042017
400	chrome	CH042014	700	chrome	CH042017
			800	RAL	KI042018
			800	zinc	ZN042018
			800	chrome	CH042018

Боковой ограничитель полки H=60 | Wire lateral for shelf H=60



K, mm	Color	It.№	K, mm	Color	It.№
200	RAL	KI042019	500	RAL	KI042022
200	zinc	ZN042019	500	zinc	ZN042022
200	chrome	CH042019	500	chrome	CH042022
300	RAL	KI042020	600	RAL	KI042023
300	zinc	ZN042020	600	zinc	ZN042023
300	chrome	CH042020	600	chrome	CH042023
400	RAL	KI042021	700	RAL	KI042024
400	zinc	ZN042021	700	zinc	ZN042024
400	chrome	CH042021	700	chrome	CH042024
			800	RAL	KI042025
			800	zinc	ZN042025
			800	chrome	CH042025

Боковой ограничитель полки H=90 | Wire lateral for shelf H=90



K, mm	Color	It.№	K, mm	Color	It.№
200	RAL	KI042026	500	RAL	KI042029
200	zinc	ZN042026	500	zinc	ZN042029
200	chrome	CH042026	500	chrome	CH042029
300	RAL	KI042027	600	RAL	KI042030
300	zinc	ZN042027	600	zinc	ZN042030
300	chrome	CH042027	600	chrome	CH042030
400	RAL	KI042028	700	RAL	KI042031
400	zinc	ZN042028	700	zinc	ZN042031
400	chrome	CH042028	700	chrome	CH042031
			800	RAL	KI042032
			800	zinc	ZN042032
			800	chrome	CH042032

Боковой ограничитель торцевой полки H=30 | Wire lateral for end shelf H=30



K, mm	L, mm	Color	It.№	K, mm	L, mm	Color	It.№
300	251	RAL	KI042224	500	405	RAL	KI042227
300	251	zinc	ZN042224	500	405	zinc	ZN042227
300	251	chrome	CH042224	500	405	chrome	CH042227
400	330	RAL	KI042227	600	494	RAL	KI042233
400	330	zinc	ZN042227	600	494	zinc	ZN042233
400	330	chrome	CH042227	600	494	chrome	CH042233

Боковой ограничитель торцевой полки H=60 | Wire lateral for end shelf H=60



K, mm	L, mm	Color	It.№	K, mm	L, mm	Color	It.№
300	251	RAL	KI042236	500	405	RAL	KI042239
300	251	zinc	ZN042236	500	405	zinc	ZN042239
300	251	chrome	CH042236	500	405	chrome	CH042239
400	330	RAL	KI042242	600	494	RAL	KI042245
400	330	zinc	ZN042242	600	494	zinc	ZN042245
400	330	chrome	CH042242	600	494	chrome	CH042245

Боковой ограничитель торцевой полки H=90 | Wire lateral for end shelf H=90



K, mm	L, mm	Color	It.№	K, mm	L, mm	Color	It.№
300	251	RAL	KI042248	500	405	RAL	KI042254
300	251	zinc	ZN042248	500	405	zinc	ZN042254
300	251	chrome	CH042248	500	405	chrome	CH042254
400	330	RAL	KI042251	600	494	RAL	KI042257
400	330	zinc	ZN042251	600	494	zinc	ZN042257
400	330	chrome	CH042251	600	494	chrome	CH042257

Средний ограничитель торцевой полки H=30 | Wire average for end shelf H=30



K, mm	L, mm	Color	It.№	K, mm	L, mm	Color	It.№
300	117	RAL	KI042223	500	184	RAL	KI042229
300	117	zinc	ZN042223	500	184	zinc	ZN042229
300	117	chrome	CH042223	500	184	chrome	CH042229
400	152	RAL	KI042226	600	218	RAL	KI042232
400	152	zinc	ZN042226	600	218	zinc	ZN042232
400	152	chrome	CH042226	600	218	chrome	CH042232

Средний ограничитель торцевой полки H=60 | Wire average for end shelf H=60



K, mm	L, mm	Color	It.№	K, mm	L, mm	Color	It.№
300	117	RAL	KI042235	500	184	RAL	KI042241
300	117	zinc	ZN042235	500	184	zinc	ZN042241
300	117	chrome	CH042235	500	184	chrome	CH042241
400	152	RAL	KI042238	600	218	RAL	KI042244
400	152	zinc	ZN042238	600	218	zinc	ZN042244
400	152	chrome	CH042238	600	218	chrome	CH042244

Средний ограничитель торцевой полки H=90 | Wire average for end shelf H=90



K, mm	L, mm	Color	It.№	K, mm	L, mm	Color	It.№
300	117	RAL	KI042247	500	184	RAL	KI042253
300	117	zinc	ZN042247	500	184	zinc	ZN042253
300	117	chrome	CH042247	500	184	chrome	CH042253
400	152	RAL	KI042250	600	218	RAL	KI042256
400	152	zinc	ZN042250	600	218	zinc	ZN042256
400	152	chrome	CH042250	600	218	chrome	CH042256

Разделители полки H=160/60 | Wire dividers of shelf H=160/60

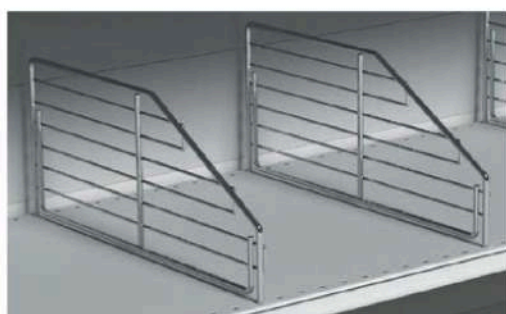

K, mm	Color	It.№	K, mm	Color	It.№
300	RAL	KI042125	600	RAL	KI042128
300	zinc	ZN042125	600	zinc	ZN042128
300	chrome	CH042125	600	chrome	CH042128
400	RAL	KI042126	700	RAL	KI042129
400	zinc	ZN042126	700	zinc	ZN042129
400	chrome	CH042126	700	chrome	CH042129
500	RAL	KI042127	800	RAL	KI042130
500	zinc	ZN042127	800	zinc	ZN042130
500	chrome	CH042127	800	chrome	CH042130

Разделители полки H=160/90 | Wire dividers of shelf H=160/90

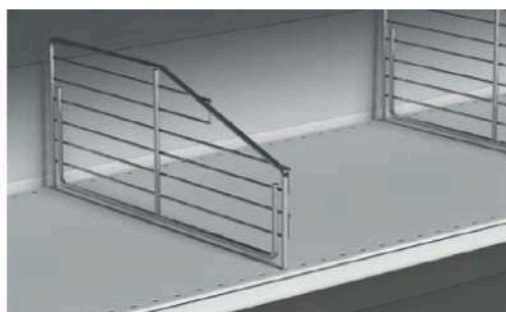

K, mm	Color	It.№	K, mm	Color	It.№
300	RAL	KI042131	600	RAL	KI042134
300	zinc	ZN042131	600	zinc	ZN042134
300	chrome	CH042131	600	chrome	CH042134
400	RAL	KI042132	700	RAL	KI042135
400	zinc	ZN042131	700	zinc	ZN042135
400	chrome	CH042131	700	chrome	CH042135
500	RAL	KI042133	800	RAL	KI042136
500	zinc	ZN042133	800	zinc	ZN042136
500	chrome	CH042133	800	chrome	CH042136

Разделители полки H=125/60 | Wire dividers of shelf H=125/60

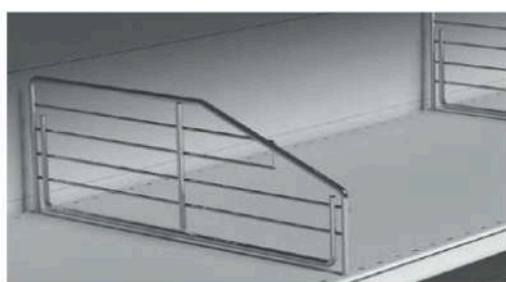

K, mm	Color	It.№	K, mm	Color	It.№
200	RAL	KI042118	500	zinc	ZN042121
200	zinc	ZN042118	500	chrome	CH042121
200	chrome	CH042118	600	RAL	KI042122
300	RAL	KI042122	600	zinc	ZN042122
300	zinc	ZN042119	600	chrome	CH042122
300	chrome	CH042119	700	RAL	KI042123
400	RAL	KI042120	700	zinc	ZN042123
400	zinc	ZN042120	700	chrome	CH042123
400	chrome	CH042120	800	RAL	KI042124
500	RAL	KI042121	800	zinc	ZN042124
			800	chrome	CH042124

Разделители полки H=200/125 | Wire dividers of shelf H=200/125

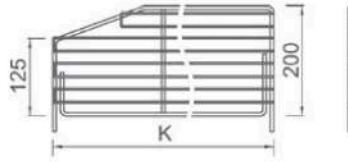
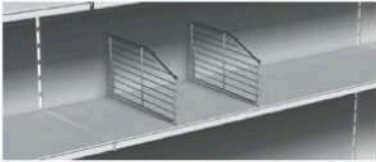

K, mm	Color	It.№	K, mm	Color	It.№	K, mm	Color	It.№
300	RAL	KI042137	400	RAL	KI042138	500	RAL	KI042139
300	zinc	ZN042137	400	zinc	ZN042138	500	zinc	ZN042139
300	chrome	CH042137	400	chrome	CH042138	500	chrome	CH042139
600	RAL	KI042140	700	RAL	KI042141	800	RAL	KI04242
600	zinc	ZN042140	700	zinc	ZN042141	800	zinc	ZN042142
600	chrome	CH042140	700	chrome	CH042141	800	chrome	CH042142

Разделители полки H=400 | Wire dividers H=400

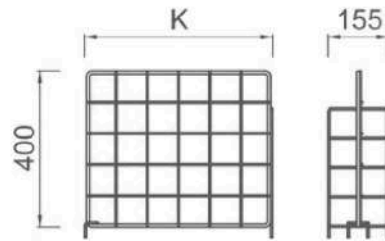

K, mm	Color	It.№	K, mm	Color	It.№
500	RAL	KI040303	600	RAL	KI040304

Гребенка задняя H=70 | Comb back H=70

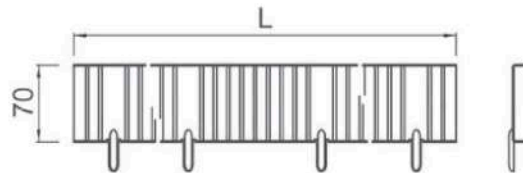
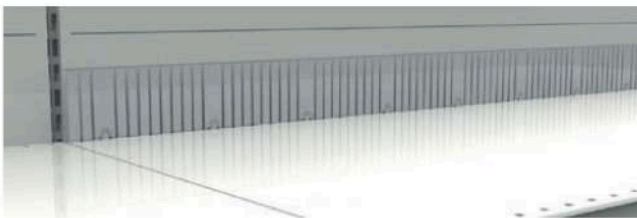

L, mm	Color	It.№	L, mm	Color	It.№	L, mm	Color	It.№	L, mm	Color	It.№
660	RAL	KI042304	1000	RAL	KI042305	1250	RAL	KI042306	1330	RAL	KI042307

Гребенка передняя H=45 | Comb front H=45

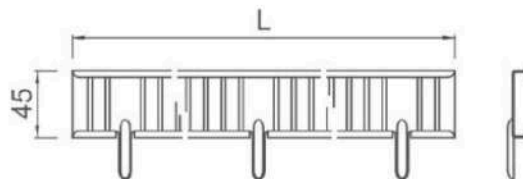

L, mm	Color	It.№	L, mm	Color	It.№	L, mm	Color	It.№	L, mm	Color	It.№
660	RAL	KI042308	1000	RAL	KI042309	1250	RAL	KI0423010	1330	RAL	KI042311

Перегородка для гребенки H=75 | Divider for comb H=75

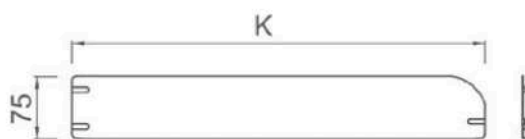

L, mm	Color	It.№	L, mm	Color	It.№	L, mm	Color	It.№
400	RAL	KI042312	500	RAL	KI042313	600	RAL	KI042314
700	RAL	KI042315	800	RAL	KI042316			

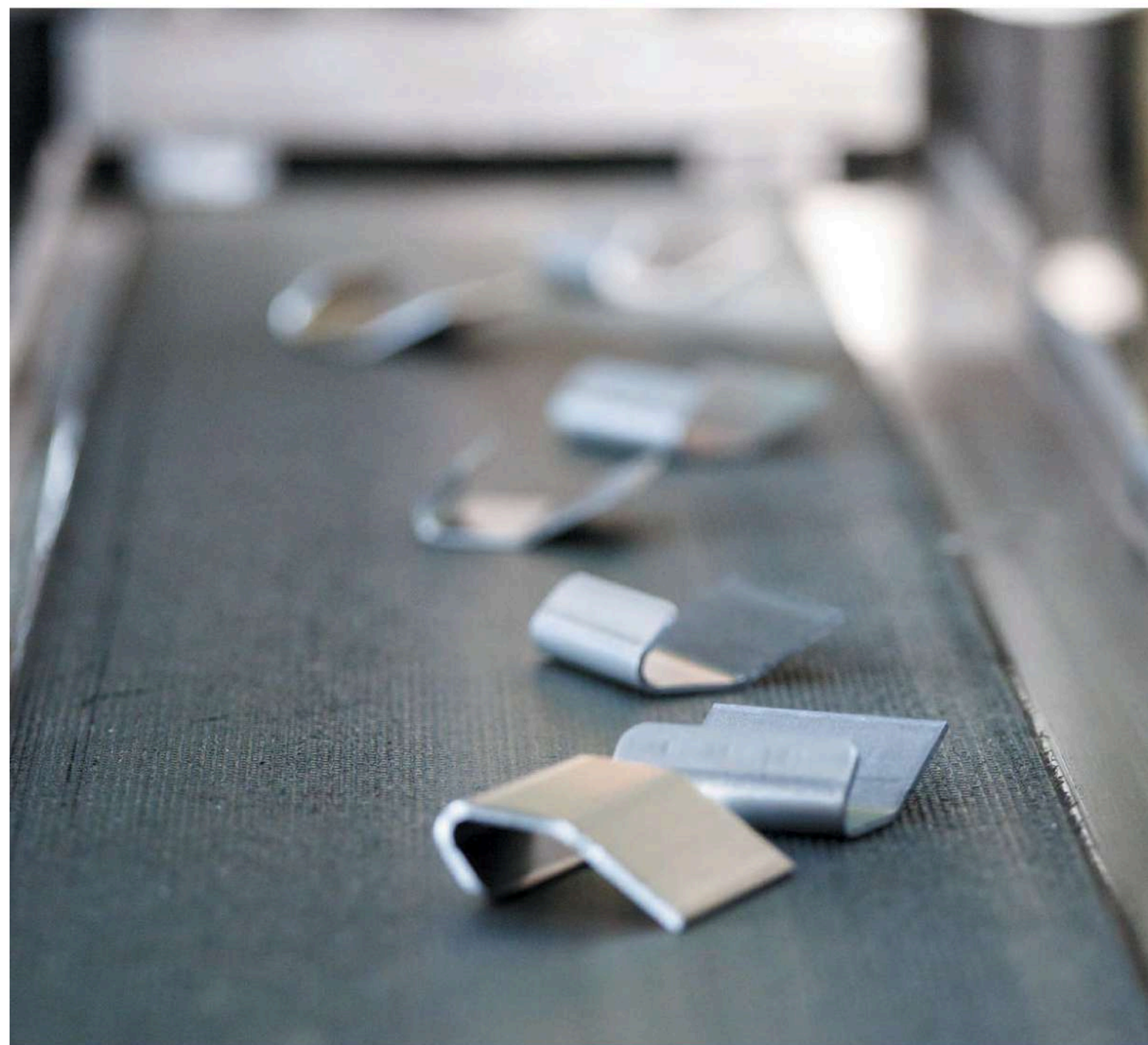

Передний ограничитель полки H=95 | Wire front for shelf H=95

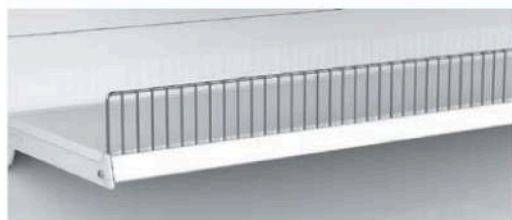

L, mm	Color	It.№	L, mm	Color	It.№	L, mm	Color	It.№	L, mm	Color	It.№
665	RAL	GK144661	1000	RAL	GK144201	1250	RAL	GK144202	1330	RAL	GK144203
665	zinc	GZ144661	1000	zinc	GZ144201	1250	zinc	GZ144202	1330	zinc	GZ144203
665	chrome	GC144661	1000	chrome	GC144201	1250	chrome	GC144202	1330	chrome	GC144203

Передний ограничитель полки H=170 | Wire front for shelf H=170

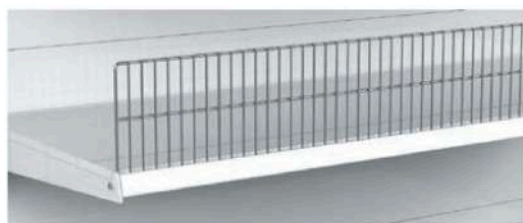

L, mm	Color	It.№	L, mm	Color	It.№	L, mm	Color	It.№	L, mm	Color	It.№
665	RAL	GK144662	1000	RAL	GK144205	1250	RAL	GK144206	1330	RAL	GK144207
665	zinc	GZ144662	1000	zinc	GK144205	1250	zinc	GZ144206	1330	zinc	GZ144207
665	chrome	GC144662	1000	chrome	GC144205	1250	chrome	GC144206	1330	chrome	GC144207

Передний ограничитель полки H=95 полки ВУ90 | Wire front for shelf H=95 for shelf internal corner 90

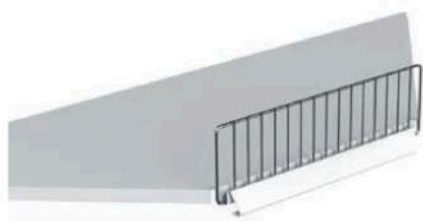

K, mm	Color	It.№	K, mm	Color	It.№	K, mm	Color	It.№
370	RAL	GK144660	470	RAL	GK144658	570	RAL	GK144656
370	zinc	GZ144660	470	zinc	GZ144658	570	zinc	GZ144656
370	chrome	GC144660	470	chrome	GC144658	570	chrome	GC144656

Передний ограничитель полки H=170 полки ВУ90 | Wire front for shelf H=170 for shelf internal corner 90



K, mm	Color	It.№	K, mm	Color	It.№	K, mm	Color	It.№
370	RAL	GK144650	470	RAL	GK144652	570	RAL	GK144654
370	zinc	GZ144650	470	zinc	GZ144652	570	zinc	GZ144654
370	chrome	GC144650	470	chrome	GC144652	570	chrome	GC144654

Передний ограничитель полки H=95 полки НУ90 | Wire front for shelf H=95 for shelf external corner 90



K, mm	Color	It.№	K, mm	Color	It.№	K, mm	Color	It.№
370	RAL	GK144649	470	RAL	GK144657	570	RAL	GK144659
370	zinc	GZ144649	470	zinc	GZ144657	570	zinc	GZ144659
370	chrome	GC144649	470	chrome	GC144657	570	chrome	GC144659

Передний ограничитель полки H=170 полки НУ90 | Wire front for shelf H=170 for shelf external corner 90



K, mm	Color	It.№	K, mm	Color	It.№	K, mm	Color	It.№
370	RAL	GK1446651	470	RAL	GK1446653	570	RAL	GK1446655
370	zinc	GZ1446651	470	zinc	GZ1446653	570	zinc	GZ1446655
370	chrome	GC1446651	470	chrome	GC1446653	570	chrome	GC1446655

Передний ограничитель полки H=95 полки ВУ45 | Wire front for shelf H=95 for shelf internal corner 45



K, mm	Color	It.№	K, mm	Color	It.№	K, mm	Color	It.№
370	RAL	GK144679	470	RAL	GK144681	570	RAL	GK144682
370	zinc	GZ144679	470	zinc	GZ144681	570	zinc	GZ144682
370	chrome	GC144679	470	chrome	GC144681	570	chrome	GC144682

Передний ограничитель полки H=170 полки ВУ45 | Wire front for shelf H=170 for shelf internal corner 45



K, mm	Color	It.№	K, mm	Color	It.№	K, mm	Color	It.№
370	RAL	GK144683	470	RAL	GK144684	570	RAL	GK144685
370	zinc	GZ144683	470	zinc	GZ144684	570	zinc	GZ144685
370	chrome	GC144683	470	chrome	GC144684	570	chrome	GC144685

Передний ограничитель полки H=95 полки НУ45 | Wire front for shelf H=95 for shelf external corner 45



K, mm	Color	It.№	K, mm	Color	It.№	K, mm	Color	It.№
370	RAL	GK144686	470	RAL	GK144687	570	RAL	GK144688
370	zinc	GZ144686	470	zinc	GZ144687	570	zinc	GZ144688
370	chrome	GC144686	470	chrome	GC144687	570	chrome	GC144688

Передний ограничитель полки H=170 полки НУ45 | Wire front for shelf H=170 for shelf external corner 45

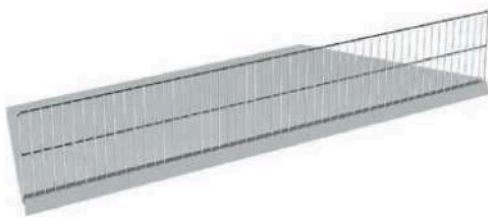

K, mm	Color	It.№	K, mm	Color	It.№	K, mm	Color	It.№
370	RAL	GK144689	470	RAL	GK144690	570	RAL	GK144691
370	zinc	GZ144689	470	zinc	GZ144690	570	zinc	GZ144691
370	chrome	GC144689	470	chrome	GC144690	570	chrome	GC144691

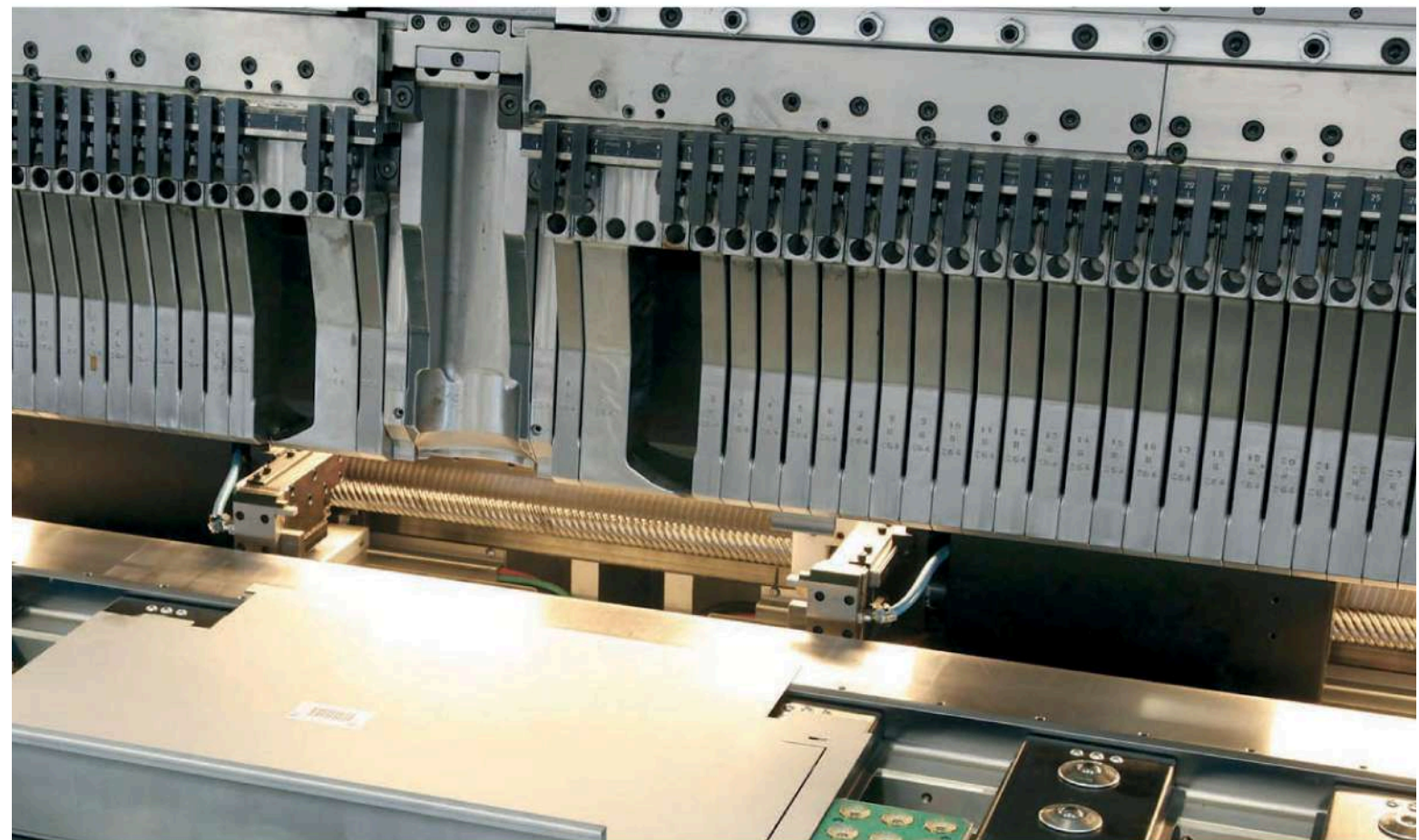

Разделители полки H=95 | Wire dividers of shelf H=95



K, mm	Color	It.№	K, mm	Color	It.№	K, mm	Color	It.№	K, mm	Color	It.№
370	RAL	GK144666	470	RAL	GK144667	570	RAL	GK144668	670	RAL	GK144669
370	zinc	GZ144666	470	zinc	GZ144667	570	zinc	GZ144668	670	zinc	GZ144669
370	chrome	GC144666	470	chrome	GC144667	570	chrome	GC144668	670	chrome	GC144669

Разделители полки H=170 | Wire dividers of shelf H=170



K, mm	Color	It.№	K, mm	Color	It.№	K, mm	Color	It.№	K, mm	Color	It.№
370	RAL	GK144670	470	RAL	GK144671	570	RAL	GK144672	670	RAL	GK144674
370	zinc	GZ144670	470	zinc	GZ144671	570	zinc	GZ144672	670	zinc	GZ144674
370	chrome	GC144670	470	chrome	GC144671	570	chrome	GC144672	670	chrome	GC144674

Комплект разделителей и ограничителей для полки передней H=95

Wire dividers set for front shelf H=95

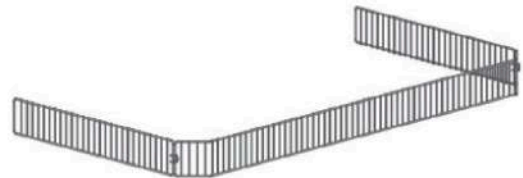

K, mm	Color	It.№	K, mm	Color	It.№	K, mm	Color	It.№
370	RAL	GK144260	470	RAL	GK144261	570	RAL	GK144262
370	zinc	GZ144260	470	zinc	GZ144261	570	zinc	GZ144262
370	chrome	GC144260	470	chrome	GC144261	570	chrome	GC144262

Комплект разделителей и ограничителей для полки передней H=170

Wire dividers set for front shelf H=170

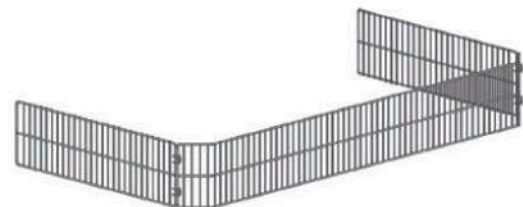

K, mm	L, mm	Color	It.№	K, mm	L, mm	Color	It.№	K, mm	L, mm	Color	It.№
370	830	RAL	GK144263	470	1030	RAL	GK144264	570	1230	RAL	GK144265
370	830	zinc	GZ144263	470	1030	zinc	GZ144264	570	1230	zinc	GZ144265
370	830	chrome	GC144263	470	1030	chrome	GC144264	570	1230	chrome	GC144265

Комплект разделителей и ограничителей для полки с выступом H=95

Wire dividers set for end shelf H=95

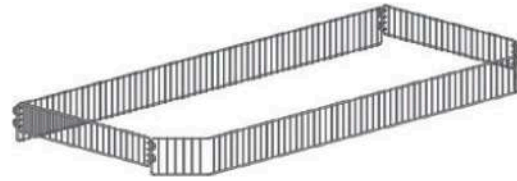

K, mm	L, mm	Color	It.№	L, мм	Color	It.№	L, мм	Color	It.№
270	1000	RAL	GK144236	1250	RAL	GK144240	1330	RAL	GK144244
270	1000	zinc	GZ144236	1250	zinc	GZ144240	1330	zinc	GZ144244
270	1000	chrome	GC144236	1250	chrome	GC144240	1330	chrome	GC144244
370	1000	RAL	GK144237	1250	RAL	GK144241	1330	RAL	GK144245
370	1000	zinc	GZ144237	1250	zinc	GZ144241	1330	zinc	GZ144245
370	1000	chrome	GC144237	1250	chrome	GC144241	1330	chrome	GC144245
470	1000	RAL	GK144238	1250	RAL	GK144242	1330	RAL	GK144246
470	1000	zinc	GZ144238	1250	zinc	GZ144242	1330	zinc	GZ144246
470	1000	chrome	GC144238	1250	chrome	GC144242	1330	chrome	GC144246
570	1000	RAL	GK144239	1250	RAL	GK144243	1330	RAL	GK144247
570	1000	zinc	GZ144239	1250	zinc	GZ144243	1330	zinc	GZ144247
570	1000	chrome	GC144239	1250	chrome	GC144243	1330	chrome	GC144247

Комплект разделителей и ограничителей для полки с выступом H=170

Wire dividers set for end shelf H=170

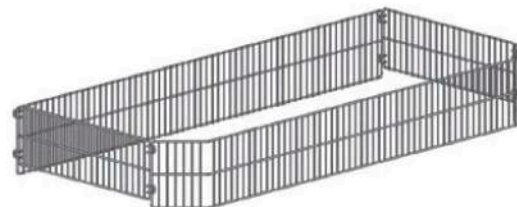

K, mm	L, mm	Color	It.№	L, мм	Color	It.№	L, мм	Color	It.№
270	1000	RAL	GK144248	1250	RAL	GK144252	1330	RAL	GK144256
270	1000	zinc	GZ144248	1250	zinc	GZ144252	1330	zinc	GZ144256
270	1000	chrome	GC144248	1250	chrome	GC144252	1330	chrome	GC144256
370	1000	RAL	GK144249	1250	RAL	GK144253	1330	RAL	GK144257
370	1000	zinc	GZ144249	1250	zinc	GZ144253	1330	zinc	GZ144257
370	1000	chrome	GC144249	1250	chrome	GC144253	1330	chrome	GC144257
470	1000	RAL	GK144250	1250	RAL	GK144254	1330	RAL	GK144258
470	1000	zinc	GZ144250	1250	zinc	GZ144254	1330	zinc	GZ144258
470	1000	chrome	GC144250	1250	chrome	GC144254	1330	chrome	GC144258
570	1000	RAL	GK144251	1250	RAL	GK144255	1330	RAL	GK144259
570	1000	zinc	GZ144251	1250	zinc	GZ144255	1330	zinc	GZ144259
570	1000	chrome	GC144251	1250	chrome	GC144255	1330	chrome	GC144259

Гребенка задняя H=50 | Comb back H=50

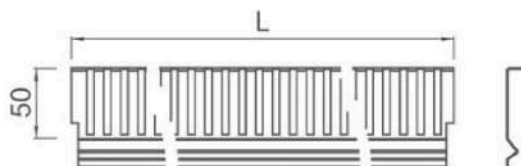

L, mm	Color	It.№	L, mm	Color	It.№	L, mm	Color	It.№	L, mm	Color	It.№
665	RAL	GK144266	1000	RAL	GK144267	1250	RAL	GK144268	1330	RAL	GK144269

Гребенка передняя H=10 | Comb front H=10

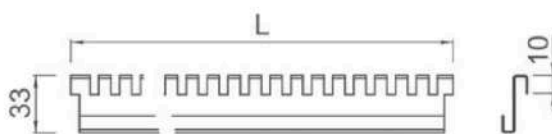

L, mm	Color	It.№	L, mm	Color	It.№	L, mm	Color	It.№	L, mm	Color	It.№
665	RAL	GK144270	1000	RAL	GK144271	1250	RAL	GK144272	1330	RAL	GK144273

Делитель полки трапецевидный H=150/75 / Divider for comb H=150/75

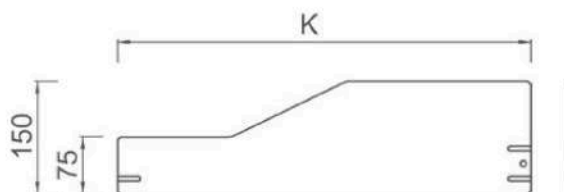

K, mm	Color	It.№	K, mm	Color	It.№	K, mm	Color	It.№	K, mm	Color	It.№
370	RAL	GK143583	470	RAL	GK143584	1250	RAL	GK143585	1330	RAL	GK143586



Балка с кронштейнами 15x30 | Beam with brackets 15x30

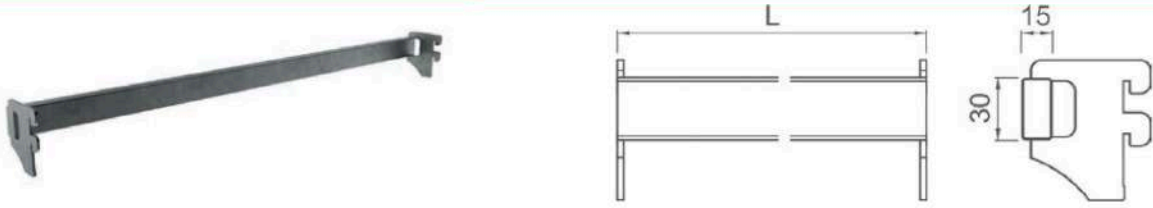

L, mm	Color	It.№	L, mm	Color	It.№	L, mm	Color	It.№	L, mm	Color	It.№
660	RAL	KI061245	1000	RAL	KI061246	1250	RAL	KI061247	1330	RAL	KI061248
660	zinc	ZN061245	1000	zinc	ZN061246	1250	zinc	ZN061247	1330	zinc	ZN061248
660	chrome	CH061245	1000	chrome	CH061246	1250	chrome	CH061247	1330	chrome	CH061248



K, mm	L, mm	Color	It.№	L, mm	Color	It.№	L, mm	Color	It.№	L, mm	Color	It.№
200	660	RAL	KI062003	1000	RAL	KI062006	1250	RAL	KI062009	1330	RAL	KI062012
300	660	zinc	KI062004	1000	zinc	KI062007	1250	zinc	KI062010	1330	zinc	KI062013
400	660	chrome	KI062005	1000	chrome	KI062008	1250	chrome	KI062011	1330	chrome	KI062014

Перфорированная балка с кронштейнами 25x50 | Beam with brackets 25x50 perforated

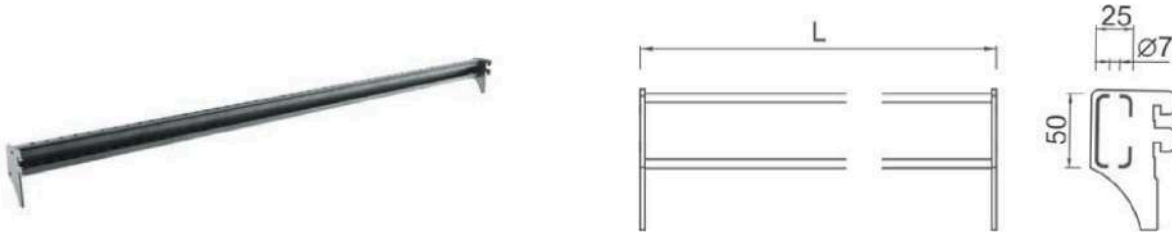

L, mm	Color	It.№	L, mm	Color	It.№	L, mm	Color	It.№	L, mm	Color	It.№
660	RAL	KI061239	1000	RAL	KI061240	1250	RAL	KI061241	1330	RAL	KI061242
660	zinc	ZN061239	1000	zinc	ZN061240	1250	zinc	ZN061241	1330	zinc	ZN061242
660	chrome	CH061239	1000	chrome	CH061240	1250	chrome	CH061241	1330	chrome	CH061242

Балка с кронштейнами 20x50 | Beam with brackets 20x50

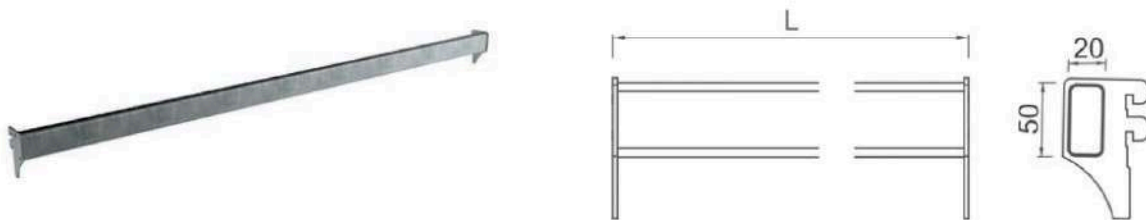

L, mm	Color	It.№	L, mm	Color	It.№	L, mm	Color	It.№	L, mm	Color	It.№
665	RAL	GK154863	1000	RAL	GK154864	1250	RAL	GK154865	1330	RAL	GK154866
665	zinc	GZ154863	1000	zinc	GZ154864	1250	zinc	GZ154865	1330	zinc	GZ154866
665	chrome	GC154863	1000	chrome	GC154864	1250	chrome	GC154865	1330	chrome	GC154866

Перфорированная балка с кронштейнами 20x50 | Beam with brackets 20x50 perforated

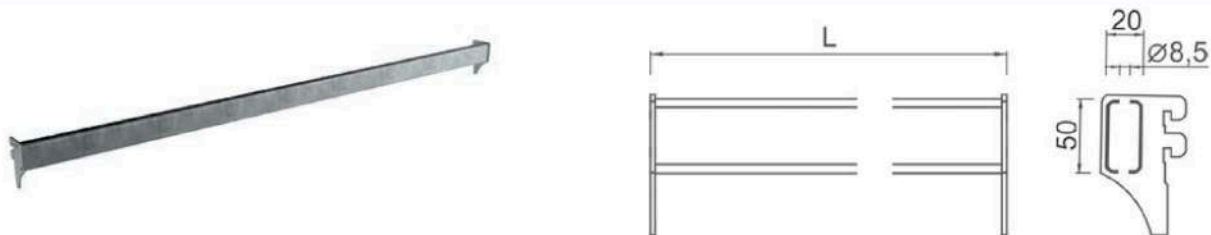

L, mm	Color	It.№	L, mm	Color	It.№	L, mm	Color	It.№	L, mm	Color	It.№
665	RAL	GK154763	1000	RAL	GK154764	1250	RAL	GK154765	1330	RAL	GK154766
665	zinc	GZ154763	1000	zinc	GZ154764	1250	zinc	GZ154765	1330	zinc	GZ154766
665	chrome	GC154763	1000	chrome	GC154764	1250	chrome	GC154765	1330	chrome	GC154766

Балка с кронштейнами 20x40 | Beam with brackets 20x40

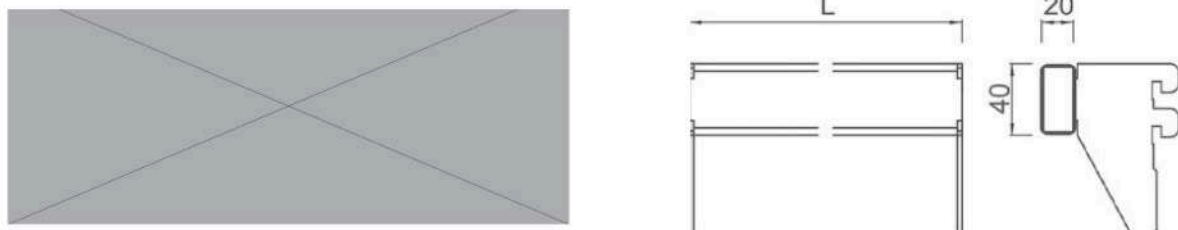

L, mm	Color	It.№	L, mm	Color	It.№	L, mm	Color	It.№	L, mm	Color	It.№
660	RAL	KI061345	1000	RAL	KI061346	1250	RAL	KI061347	1330	RAL	KI061348
660	zinc	ZN061345	1000	zinc	ZN061346	1250	zinc	ZN061347	1330	zinc	ZN061348
660	chrome	CH061345	1000	chrome	CH061346	1250	chrome	CH061347	1330	chrome	CH061348

Сепаратор гребенчатый на балку 20x40 | Separator on beam 20x40

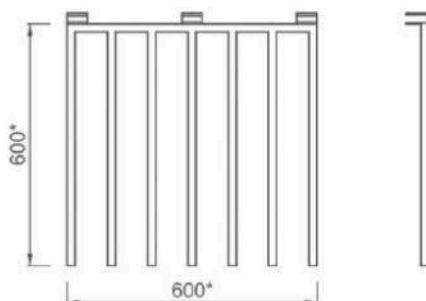
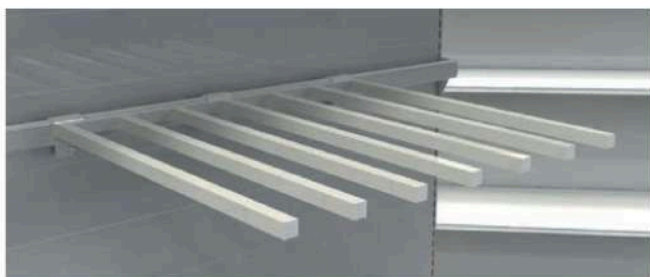

Color	It.№
RAL	KI061349

Сепаратор рамочный на балку 20x40 | Frame-separator on beam 20x40

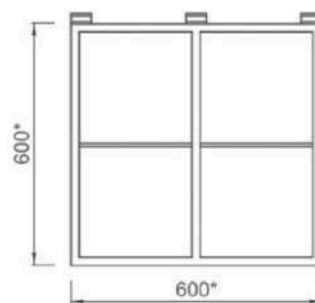

Color	It.№
RAL	KI061349

Сепаратор | Separator

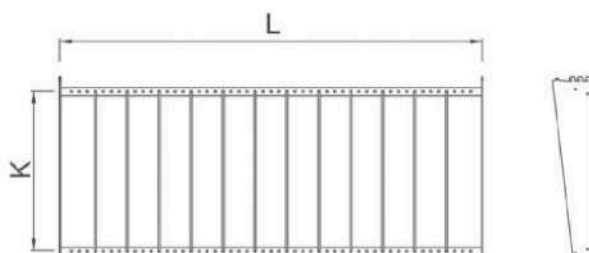

K, mm	L, mm	Разделители	Color	It.№	L, mm	Разделители	Color	It.№
500	660	6	RAL	KI220034	1000	9	RAL	KI220035
500	1250	12	RAL	KI220036	1330	12	RAL	KI220037
600	660	6	RAL	KI220038	1000	9	RAL	KI220039
600	1250	12	RAL	KI220040	1330	12	RAL	KI220041
700	660	6	RAL	KI220042	1000	9	RAL	KI220043
700	1250	12	RAL	KI220044	1330	12	RAL	KI220045
800	660	6	RAL	KI220046	1000	9	RAL	KI220047
800	1250	12	RAL	KI220048	1330	12	RAL	KI220049

Крюк одинарный на балку | Single hook for beam 15x30

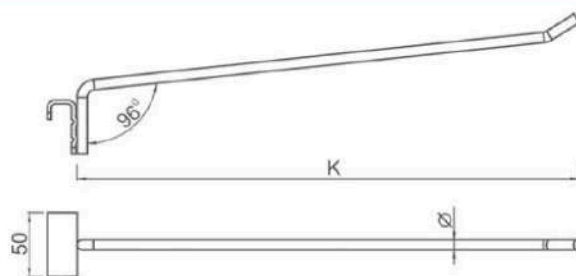
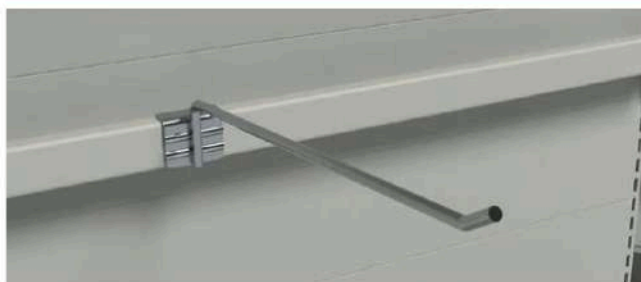

Ø, mm	K, mm	Color	It.№	K, mm	Color	It.№	K, mm	Color	It.№	L, mm	Color	It.№
6	200	RAL	KI061138	300	RAL	KI061139	400	RAL	KI061140			
6	200	zinc	ZN061138	300	zinc	ZN061139	400	zinc	ZN061140			
6	200	chrome	CH061138	300	chrome	CH061139	400	chrome	CH061140			
8	200	RAL	KI061141	300	RAL	KI061142	400	RAL	KI061143	500	RAL	KI061144
8	200	zinc	ZN061141	300	zinc	ZN061142	400	zinc	ZN061143	500	zinc	ZN061144
8	200	chrome	CH061141	300	chrome	CH061142	400	chrome	CH061143	500	chrome	CH061144
10	500	RAL	KI061145	600	RAL	KI061146						
10	500	zinc	ZN061145	600	zinc	ZN061146						
10	500	chrome	CH061145	600	chrome	CH061146						

Крюк одинарный с ценникодержателем на балку | Single hook with price tag holder for beam 15x30

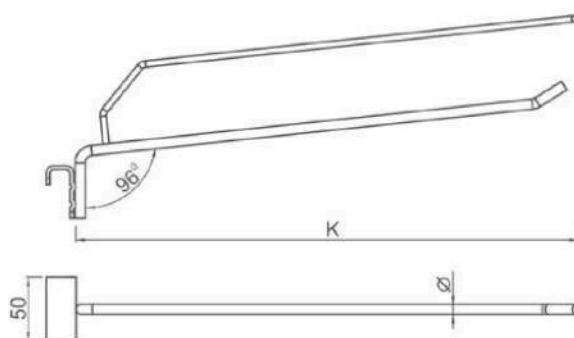
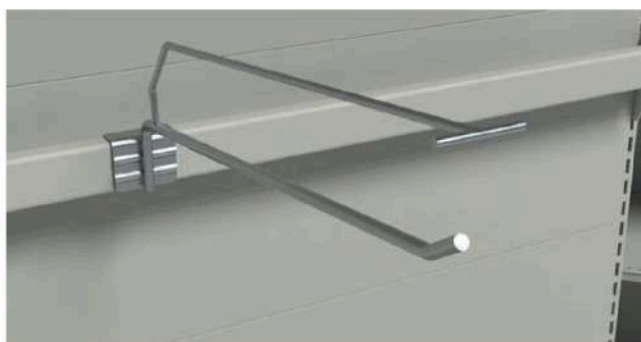

Ø, mm	K, mm	Color	It.№	K, mm	Color	It.№	K, mm	Color	It.№	L, mm	Color	It.№
6	200	RAL	KI061147	300	RAL	KI061148	400	RAL	KI061149			
6	200	zinc	ZN061147	300	zinc	ZN061148	400	zinc	ZN061149			
6	200	chrome	CH061147	300	chrome	CH061148	400	chrome	CH061149			
8	200	RAL	KI061150	300	RAL	KI061151	400	RAL	KI061152	500	RAL	KI061153
8	200	zinc	ZN061150	300	zinc	ZN061151	400	zinc	ZN061152	500	zinc	ZN061153
8	200	chrome	CH061150	300	chrome	CH061151	400	chrome	CH061152	500	chrome	CH061153
10	500	RAL	KI061154	600	RAL	KI061155						
10	500	zinc	ZN061154	600	zinc	ZN061155						
10	500	chrome	CH061154	600	chrome	CH061155						

Крюк двойной для балки | Double hook for beam 15x30

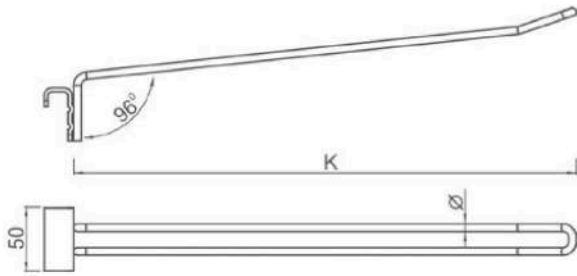
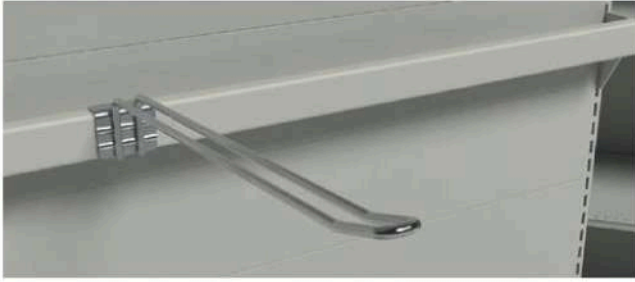

Ø, mm	K, mm	Color	It.№	K, mm	Color	It.№	K, mm	Color	It.№
5	200	RAL	KI061132	300	RAL	KI061133	400	RAL	KI061134
5	200	zinc	ZN061132	300	zinc	ZN061133	400	zinc	ZN061134
5	200	chrome	CH061132	300	chrome	CH061133	400	chrome	CH061134
6	200	RAL	KI061135	300	RAL	KI061136	400	RAL	KI061137
6	200	zinc	ZN061135	300	zinc	ZN061136	400	zinc	ZN061137
6	200	chrome	CH061135	300	chrome	CH061136	400	chrome	CH061137

Вешалка для одежды изогнутая с наклоном и ценником на балку 15x30

Inclined tubular hanger for clothes with price tag for beam 15x30

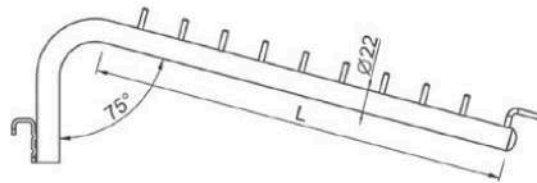
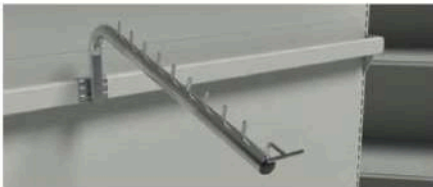

L, mm	Color	It.№	L, mm	Color	It.№	L, mm	Color	It.№	L, mm	Color	It.№
300	RAL	KI061219	400	RAL	KI061220	500	RAL	KI061221	600	RAL	KI061222
300	zinc	ZN061219	400	zinc	ZN061220	500	zinc	ZN061221	600	zinc	ZN061222
300	chrome	CH061219	400	chrome	CH061220	500	chrome	CH061221	600	chrome	CH061222

Вешалка для одежды изогнутая с наклоном на балку 15x30

Inclined tubular hanger for clothes for beam 15x30

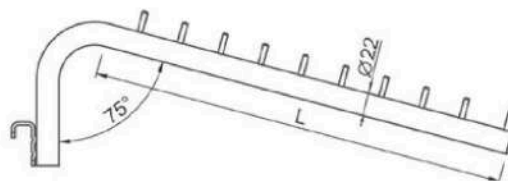
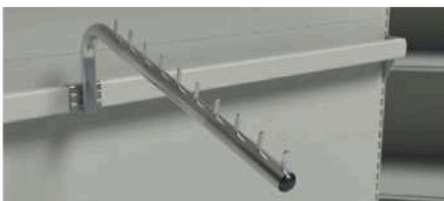

L, mm	Color	It.№	L, mm	Color	It.№	L, mm	Color	It.№	L, mm	Color	It.№
300	RAL	KI061215	400	RAL	KI061216	500	RAL	KI061217	600	RAL	KI061218
300	zinc	ZN061215	400	zinc	ZN061216	500	zinc	ZN061217	600	zinc	ZN061218
300	chrome	CH061215	400	chrome	CH061216	500	chrome	CH061217	600	chrome	CH061218

Вешалка для одежды с наклоном на балку 15x30 | Inclined hanger for clothes for beam 15x30

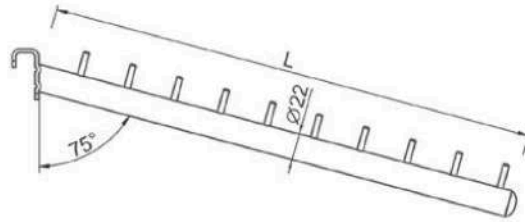

L, mm	Color	It.№	L, mm	Color	It.№	L, mm	Color	It.№	L, mm	Color	It.№
300	RAL	KI061207	400	RAL	KI061208	500	RAL	KI061209	600	RAL	KI061210
300	zinc	ZN061207	400	zinc	ZN061208	500	zinc	ZN061209	600	zinc	ZN061210
300	chrome	CH061207	400	chrome	CH061208	500	chrome	CH061209	600	chrome	CH061210

Вешалка для одежды с наклоном и ценникодержателем | Inclined hanger for clothes with tag for beam 15x30

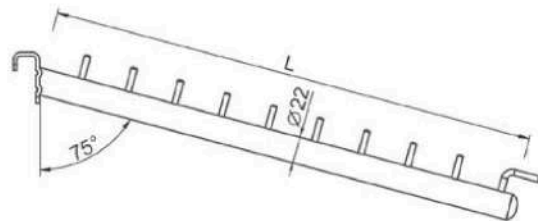
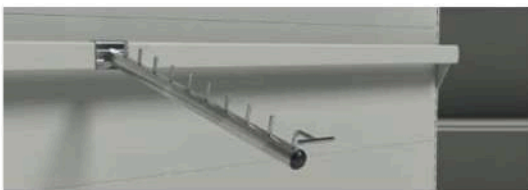

L, mm	Color	It.№	L, mm	Color	It.№	L, mm	Color	It.№	L, mm	Color	It.№
300	RAL	KI061211	400	RAL	KI061212	500	RAL	KI061213	600	RAL	KI061214
300	zinc	ZN061211	400	zinc	ZN061212	500	zinc	ZN061213	600	zinc	ZN061214
300	chrome	CH061211	400	chrome	CH061212	500	chrome	CH061213	600	chrome	CH061214

Вешалка для одежды | Hanger for clothes for beam 15x30

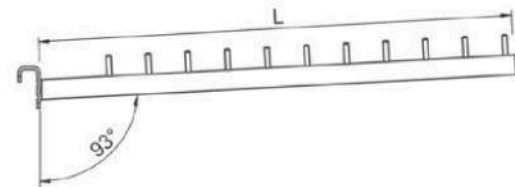

L, mm	Color	It.№	L, mm	Color	It.№	L, mm	Color	It.№	L, mm	Color	It.№
300	RAL	KI061359	400	RAL	KI061360	500	RAL	KI061361	600	RAL	KI061362
300	zinc	ZN061359	400	zinc	ZN061360	500	zinc	ZN061361	600	zinc	ZN061362
300	chrome	CH061359	400	chrome	CH061360	500	chrome	CH061361	600	chrome	CH061362

Вешалка для одежды с ценникодержателем на балку | Hanger for clothes with price tag for beam 15x30

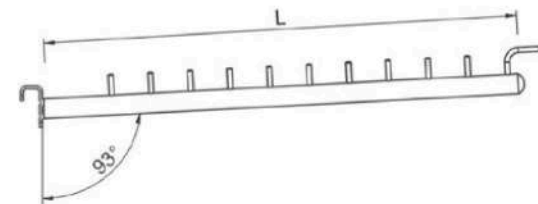
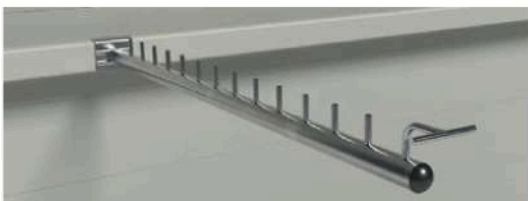

L, mm	Color	It.№	L, mm	Color	It.№	L, mm	Color	It.№	L, mm	Color	It.№
300	RAL	KI061363	400	RAL	KI061364	500	RAL	KI061365	600	RAL	KI061366
300	zinc	ZN061363	400	zinc	ZN061364	500	zinc	ZN061365	600	zinc	ZN061366
300	chrome	CH061363	400	chrome	CH061364	500	chrome	CH061365	600	chrome	CH061366

Вешалка изогнутая с наклоном и ценникодержателем | Hanger for clothes with price tag for beam 15x30

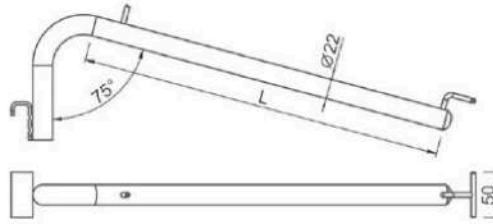
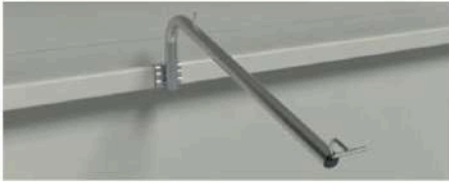

L, mm	Color	It.№	L, mm	Color	It.№	L, mm	Color	It.№	L, mm	Color	It.№
300	RAL	KI061231	400	RAL	KI061232	500	RAL	KI061233	600	RAL	KI061234
300	zinc	ZN061231	400	zinc	ZN061232	500	zinc	ZN061233	600	zinc	ZN061234
300	chrome	CH061231	400	chrome	CH061232	500	chrome	CH061233	600	chrome	CH061234

Вешалка изогнутая с наклоном | Inclined tubular hanger for beam 15x30

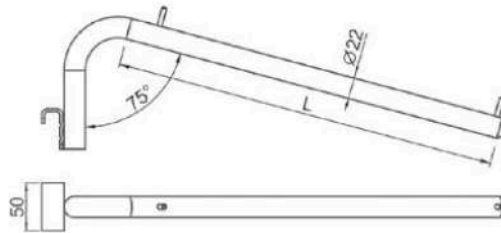
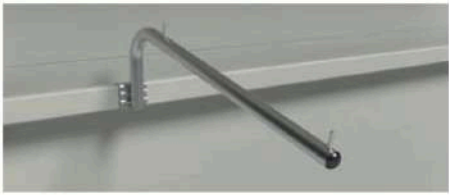

L, mm	Color	It.№	L, mm	Color	It.№	L, mm	Color	It.№	L, mm	Color	It.№
300	RAL	KI061227	400	RAL	KI061228	500	RAL	KI061229	600	RAL	KI061230
300	zinc	ZN061227	400	zinc	ZN061228	500	zinc	ZN061229	600	zinc	ZN061230
300	chrome	CH061227	400	chrome	CH061228	500	chrome	CH061229	600	chrome	CH061230

Вешалка на балку 15x30 | Hanger for beam 15x30

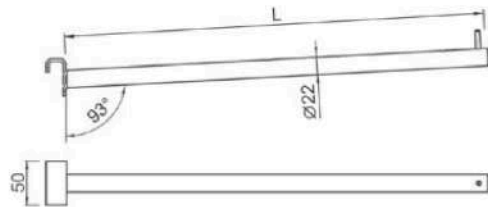

L, mm	Color	It.№	L, mm	Color	It.№	L, mm	Color	It.№	L, mm	Color	It.№
300	RAL	KI061235	400	RAL	KI061236	500	RAL	KI061237	600	RAL	KI061238
300	zinc	ZN061235	400	zinc	ZN061236	500	zinc	ZN061237	600	zinc	ZN061238
300	chrome	CH061235	400	chrome	CH061236	500	chrome	CH061237	600	chrome	CH061238

Вешалка на балку 15x30 с ценникодержателем | Hanger for beam 15x30 with price tag

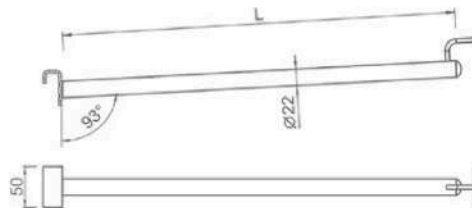
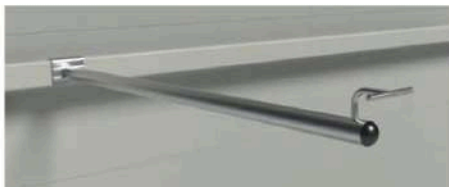

L, mm	Color	It.№	L, mm	Color	It.№	L, mm	Color	It.№	L, mm	Color	It.№
300	RAL	KI061335	400	RAL	KI061336	500	RAL	KI061337	600	RAL	KI061338
300	zinc	ZN061335	400	zinc	ZN061336	500	zinc	ZN061337	600	zinc	ZN061338
300	chrome	CH061335	400	chrome	CH061336	500	chrome	CH061337	600	chrome	CH061338

Крюк для тапочек | Hook for slipper

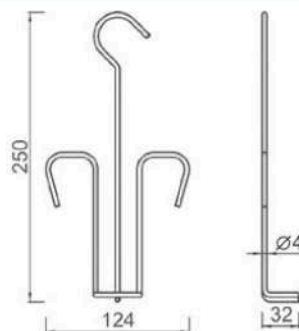

Color	It.№
RAL	KI061301

Крюк для скейтборда | Hook for skateboard for beam 15x30

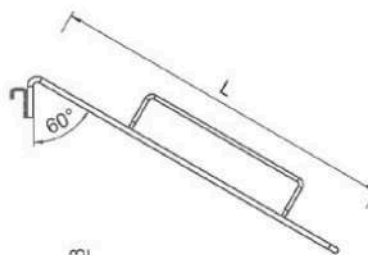
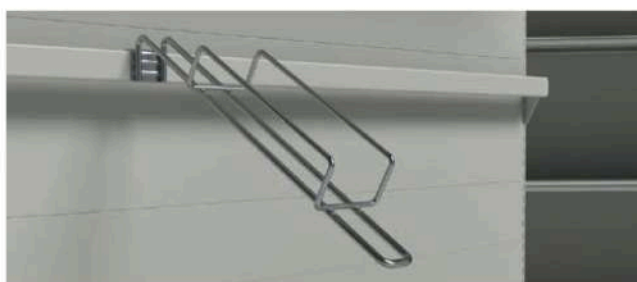

L, mm	Color	It.№	L, mm	Color	It.№
400	RAL	KI061291	500	RAL	KI061292
400	zinc	ZN06291	500	zinc	ZN061292
400	chrome	CH061291	500	chrome	CH061292

Крюк для роликовых коньков с ценникодержателем | Hook for roller with price tag for beam 15x30

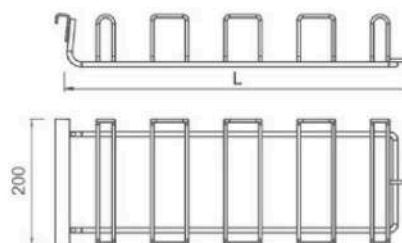
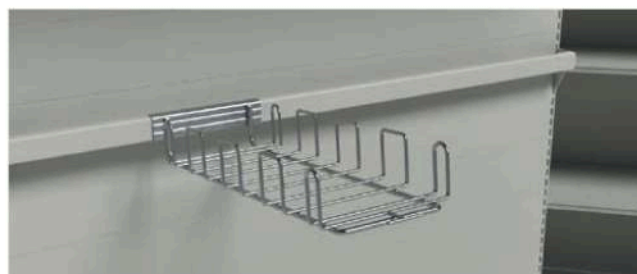

L, mm	Color	It.№	L, mm	Color	It.№
400	RAL	KI061406	500	RAL	KI061400
400	zinc	ZN061406	500	zinc	ZN061400
400	chrome	CH061406	500	chrome	CH061400

Крюк для мячей с наклоном и ценникодержателем | Inclined hook for balls with price tag for beam 15x30

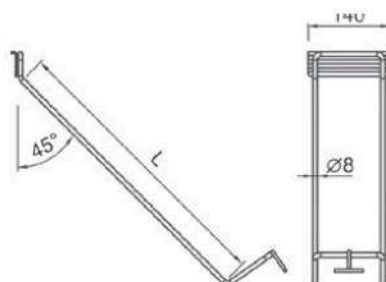

L, mm	Color	It.№
500	RAL	KI061300
500	zinc	ZN061300
500	chrome	CH061300

Крюк для мячей | Hook for balls for beam 15x30

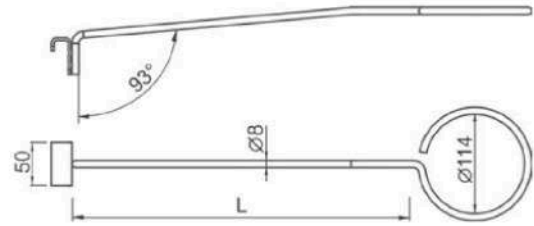
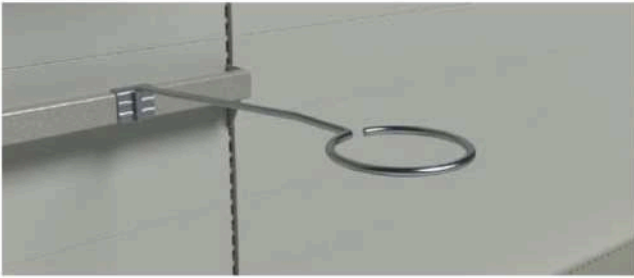

L, mm	Color	It.№	L, mm	Color	It.№
400	RAL	KI061382	500	RAL	KI061383
400	zinc	ZN061382	500	zinc	ZN061383
400	chrome	CH061382	500	chrome	CH061383

Крюк для гантелей | Hook for dumbbells for beam 15x30

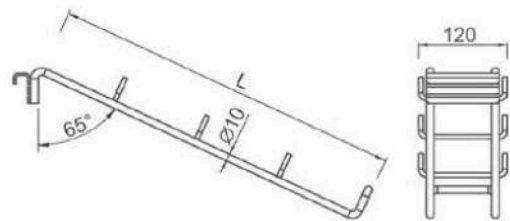

L, mm	Color	It.№	L, mm	Color	It.№
400	RAL	KI061384	500	RAL	KI061385
400	zinc	ZN061384	500	zinc	ZN061385
400	chrome	CH061384	500	chrome	CH061385

Крюк для теннисных ракеток | Hook for tennis racket for beam 15x30

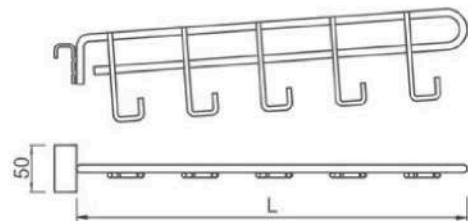

L, mm	Color	It.№	L, mm	Color	It.№
400	RAL	KI061386	500	RAL	KI061387
400	zinc	ZN061386	500	zinc	ZN061387
400	chrome	CH061386	500	chrome	CH061387

Крюк для утюга с ценникодержателем | Single wire hanger for electric iron for beam 15x30

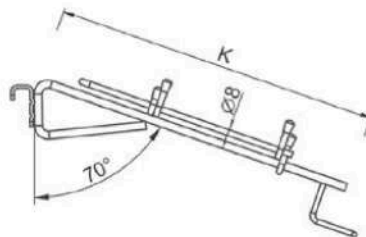
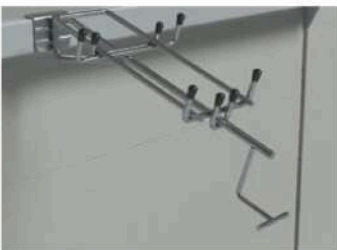

K, mm	Color	It.№	K, mm	Color	It.№	K, mm	Color	It.№
300	RAL	KI061375	400	RAL	KI061306	500	RAL	KI061376
300	zinc	ZN061375	400	zinc	ZN061306	500	zinc	ZN061376
300	chrome	CH061375	400	chrome	CH061306	500	chrome	CH061376

Крюк для фена | Hair dryer display with price tag for beam 15x30

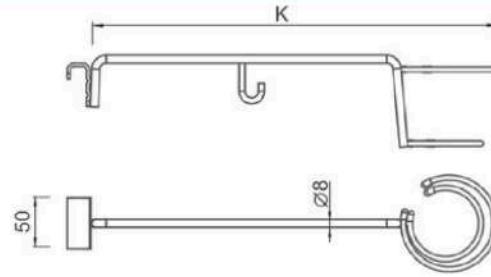

K, mm	Color	It.№	K, mm	Color	It.№	K, mm	Color	It.№
300	RAL	KI061264	400	RAL	KI061265	500	RAL	KI061266
300	zinc	ZN061264	400	zinc	ZN061265	500	zinc	ZN061266
300	chrome	CH061264	400	chrome	CH061265	500	chrome	CH061266

Крюк для фен-щеток с ценником | Hair dryer display with price tag for beam 15x30

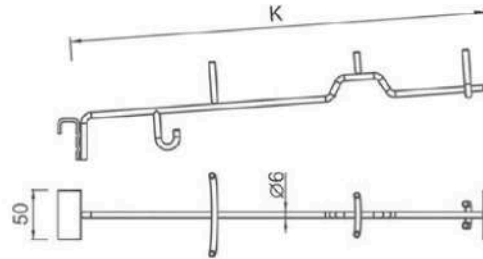

K, mm	Color	It.№	K, mm	Color	It.№	K, mm	Color	It.№
300	RAL	KI061375	400	RAL	KI061306	500	RAL	KI061376
300	zinc	ZN061375	400	zinc	ZN061306	500	zinc	ZN061276
300	chrome	CH061375	400	chrome	CH061306	500	chrome	CH061276

Крюк для блендера | Hook for blender for beam 15x30

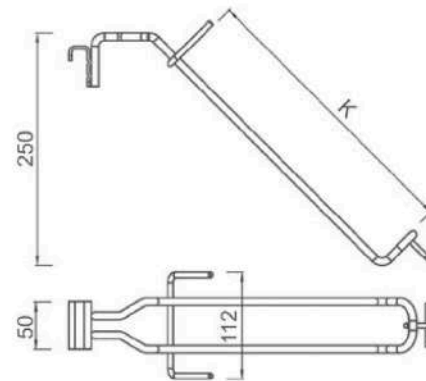

K, mm	Color	It.№	K, mm	Color	It.№
300	RAL	KI061344	150	RAL	KI061343
300	zinc	ZN061244	150	zinc	ZN061243
300	chrome	CH061244	150	chrome	CH061243

Держатель для ковриков на балку 20 x 40 | Holder for rugs on beam 20x40

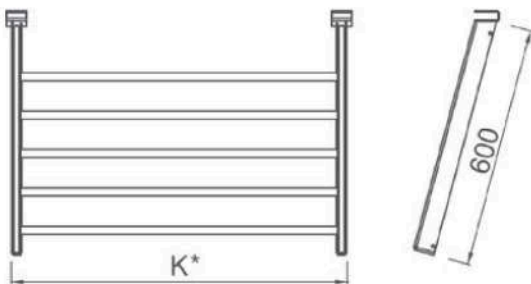

K, mm	Color	It.№	K, mm	Color	It.№	K, mm	Color	It.№	K, mm	Color	It.№
660	RAL	KI061444	1000	RAL	KI061445	1250	RAL	KI061446	1330	RAL	KI061447

Держатель для обоев на балку 20x40 | Holder for wall-paper on beam 20x40

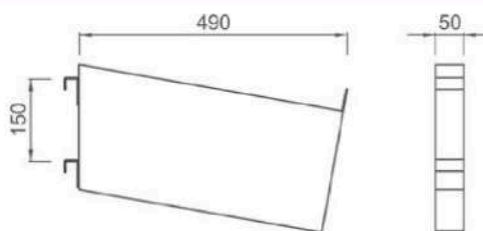
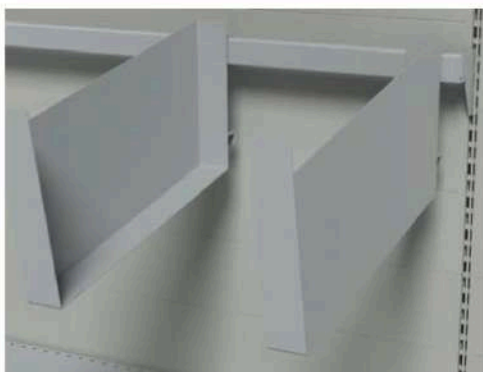

Position	Color	It.№
Left	RAL	KI061300
Right	zinc	ZN061300

Держатель для покрывал и одеял | Holder for blankets

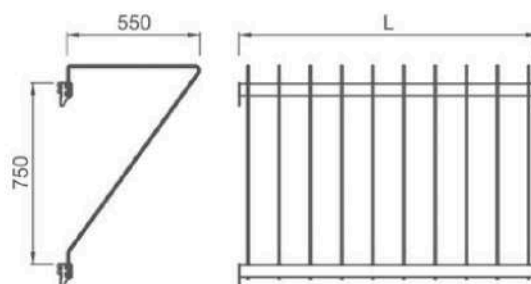
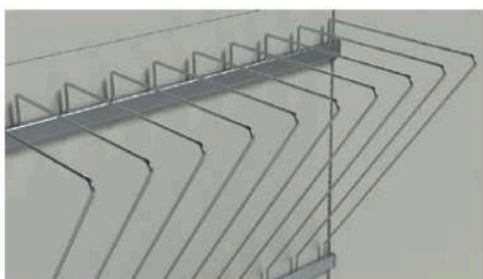

L, mm	Color	It.№	L, mm	Color	It.№	L, mm	Color	It.№	L, mm	Color	It.№
660	RAL	KI061448	1000	RAL	KI061449	1250	RAL	KI061450	1330	RAL	KI061451

Держатель для тюля | Holder for tulle for beam 15x30

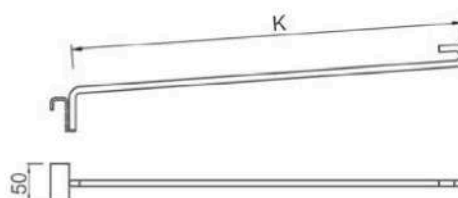

K, mm	Color	It.№	K, mm	Color	It.№	K, mm	Color	It.№
400	RAL	KI61440	500	RAL	KI061441	600	RAL	KI061442
400	zinc	ZN061440	500	zinc	ZN061441	600	zinc	ZN061442
400	chrome	CH061440	500	chrome	CH061441	600	chrome	CH061442

Держатель для пылесоса | Holder for vacuum cleaner with holder of pipes and hoses, for beam 15x30

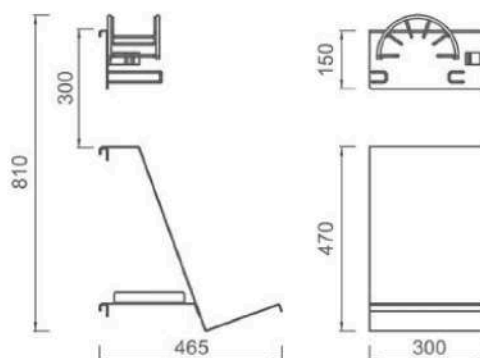
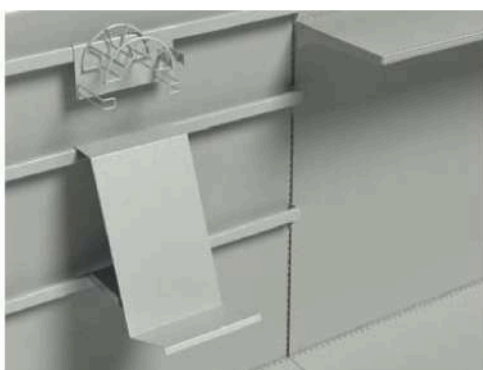

Color	It.№
RAL	KI061307

Держатель для пылесоса сеточный | Holder for vacuum cleaner wire with holder of pipes for beam 15x30

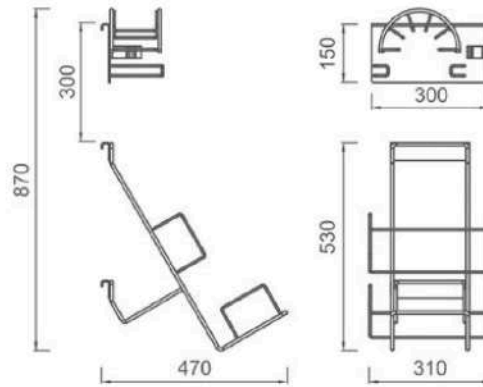
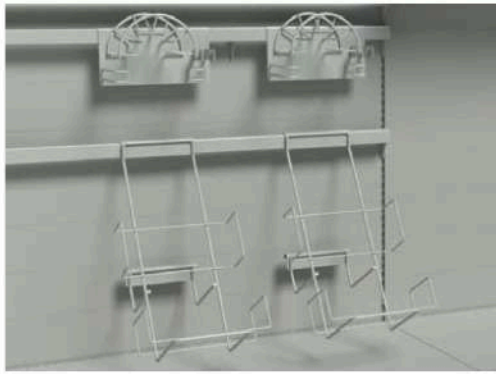

Color | It.№
RAL | KI061334

Держатель труб и шлангов пылесоса | Holder of pipes and vacuum cleaner hoses

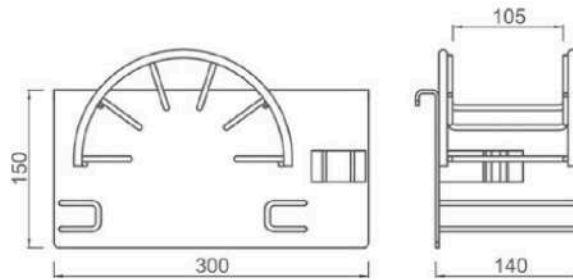
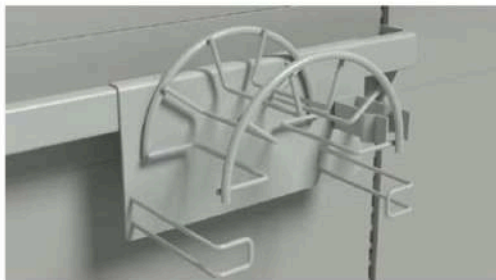

Color | It.№
RAL | KI061333

Сетчатая панель для электроинструментов | Wire panel for electrotools for beam 15x30



K, mm	Color	It.№	K, mm	Color	It.№	K, mm	Color	It.№	K, mm	Color	It.№
660	RAL	KI060044	1000	RAL	KI060045	1250	RAL	KI060046	1330	RAL	KI060047

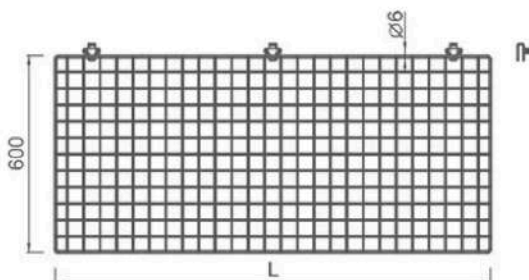

Держатель для соединяющих шлангов | Holder for connecting hoses for beam 15x30

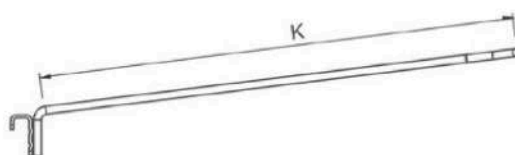

K, mm	Color	It.№
500	RAL	KI061393
500	zinc	ZN061393
500	chrome	CH061393

Держатель для шуруповертов | Holder for screw for beam 15x30

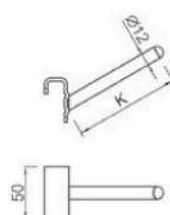
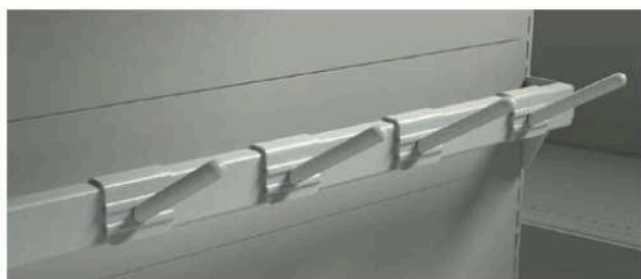

K, mm	Color	It.№
100	RAL	KI061397
100	zinc	ZN061397
100	chrome	CH061397

Держатель для отрезных дисков с ценникодержателем | Holder for cutting wheels with price tag

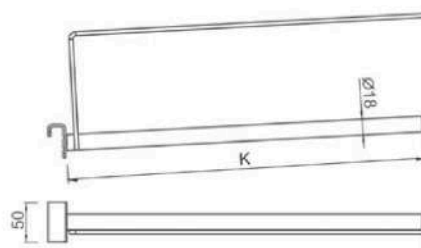

K, mm	Color	It.№
450	RAL	KI061395
450	zinc	ZN061395
450	chrome	CH061395

Держатель для электрической пилы с ценникодержателем | Holder for electrical saw with price tag

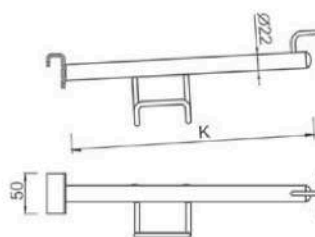

K, mm	Color	It.№
400	RAL	KI061396
400	zinc	ZN061396
400	chrome	CH061396

Держатель для кельм | Holder for trowels for beam 15x30

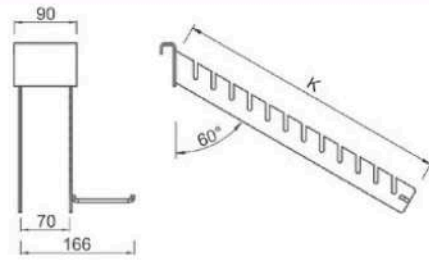
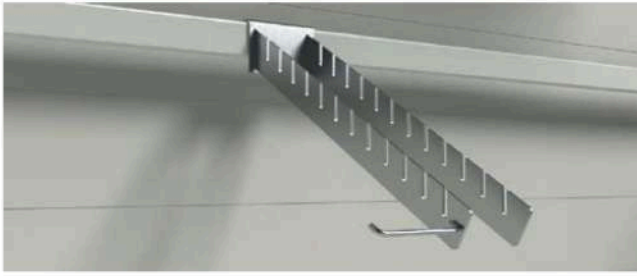

K, mm	Color	It.№
400	RAL	KI061394
400	zinc	ZN061394
400	chrome	CH061394

Крюк для молотков с ценникодержателем | Hook for hammers with price tag, for beam 15x30

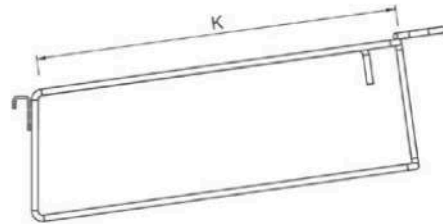

K, mm	Color	It.№	K, mm	Color	It.№
400	RAL	KI061185	500	RAL	KI061186
400	zinc	ZN061185	500	zinc	ZN061186
400	chrome	CH061185	500	chrome	CH061186

Крюк для отверток | Hook for screwdrivers for beam 15x30

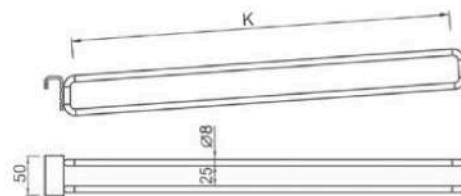
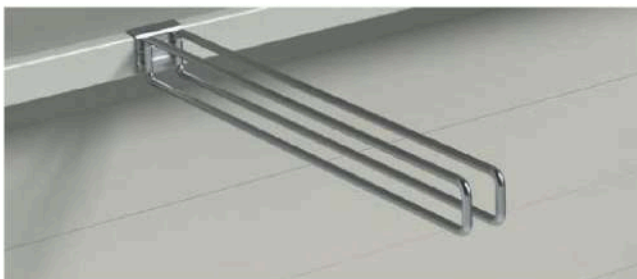

K, mm	Color	It.№	K, mm	Color	It.№
400	RAL	KI061189	500	RAL	KI061190
400	zinc	ZN061189	500	zinc	ZN061190
400	chrome	CH061189	500	chrome	CH061190

Подставка для щипцов | Support for nippers for beam 15x30

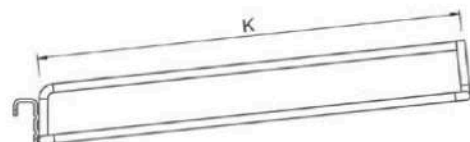

K, mm	Color	It.№	K, mm	Color	It.№
400	RAL	KI061380	500	RAL	KI061381
400	zinc	ZN061380	500	zinc	ZN061381
400	chrome	CH061380	500	chrome	CH061381

Крюк для садовых инструментов | Hook for garden tools for beam 15x30

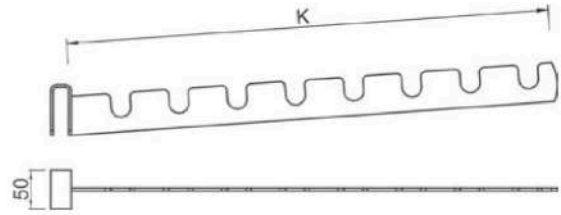
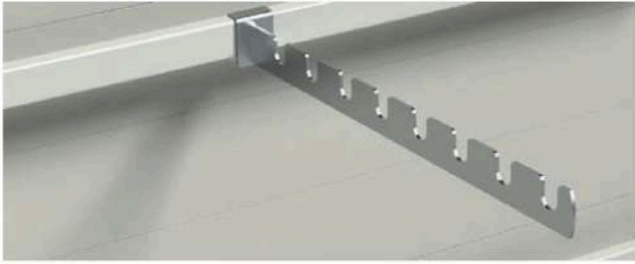

K, mm	Color	It.№	K, mm	Color	It.№	K, mm	Color	It.№
400	RAL	KI061324	500	RAL	KI061325	600	RAL	KI061326

Крюк для электроинструментов | Hook for electric tools for beam 15x30

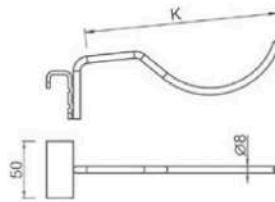
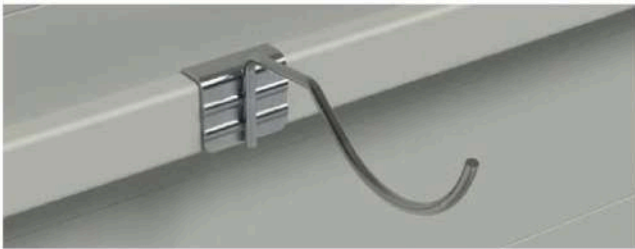

K, mm	Color	It.№
180	RAL	KI061323
180	zinc	ZN061323
180	chrome	CH061323

Крюк для ручной пилы | Hook for a hand saw for beam 15x30

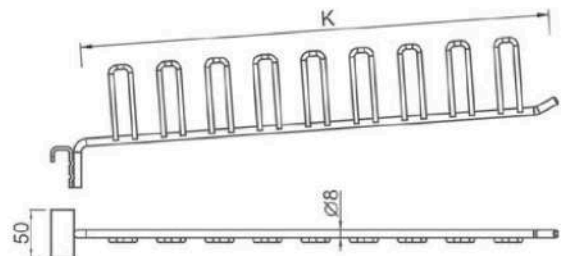

K, mm	Color	It.№	K, mm	Color	It.№	K, mm	Color	It.№
400	RAL	KI061327	500	RAL	KI061328	600	RAL	KI061329

Держатель топора | Axe holder

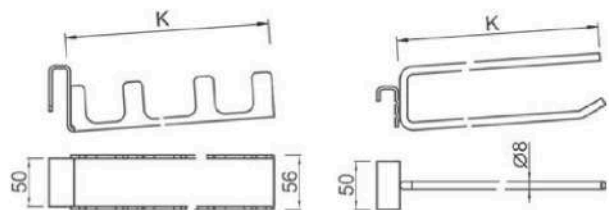
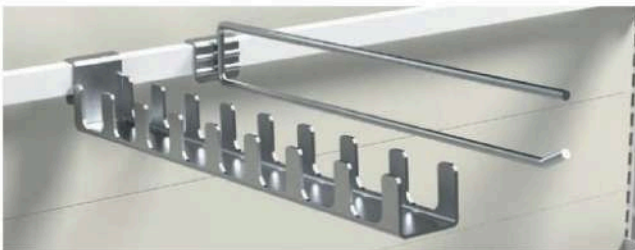

K, mm	Color	It.№	K, mm	Color	It.№	K, mm	Color	It.№
400	RAL	KI061377	500	RAL	KI061378	600	RAL	KI061379
400	zinc	ZN061377	500	zinc	ZN061378	600	zinc	ZN061379

Крюк для газонокосилок | Hook for lawn-mower for beam 15x30

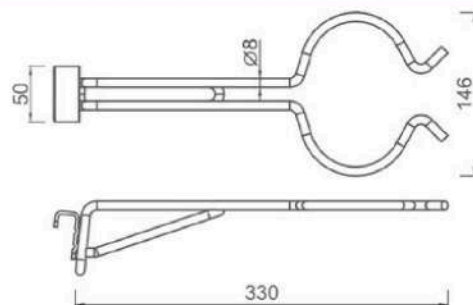

Color | It.№
RAL | KI061302

Подставка для кофейных чашек и блюдец с ценникодержателем | Support for cups with price tag

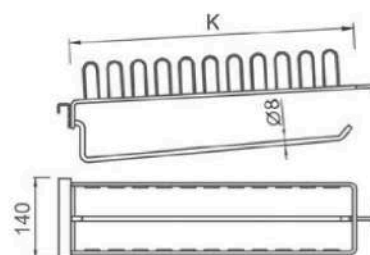
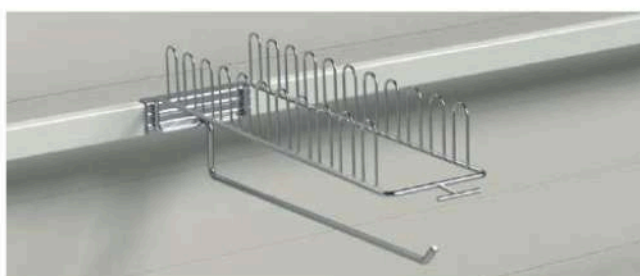

Подставка для крышек М-образная | Support for cover with price tag for beam 15x30

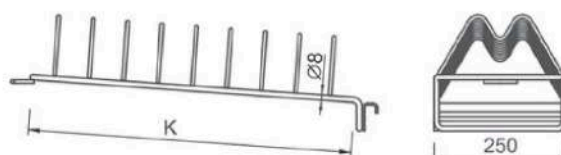

K, mm	Color	It.№	K, mm	Color	It.№
400	RAL	KI061313	500	RAL	KI061314
400	zinc	ZN061313	500	zinc	ZN061314
400	chrome	CH061313	500	chrome	CH061314

Подставка для посуды полукруглая | Support for plates with a mobile wall with price tag for beam 15x30

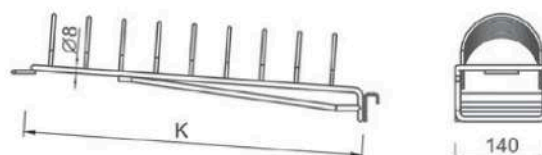

K, mm	Color	It.№	K, mm	Color	It.№
400	RAL	KI061267	500	RAL	KI061268
400	zinc	ZN061267	500	zinc	ZN061268
400	chrome	CH061267	500	chrome	CH061268

Подставка для тарелок с передвижной стенкой | Support for plates with a mobile wall with price tag



K, mm	Color	It.№	K, mm	Color	It.№	K, mm	Color	It.№
400	RAL	KI061261	500	RAL	KI061262	600	RAL	KI061263
400	zinc	ZN061261	500	zinc	ZN061262	600	zinc	ZN061263
400	chrome	CH061261	500	chrome	CH061262	600	chrome	CH061263

Рамочный разделитель P2 на балку 15x30 | Frame divider P2 for beam 15x30

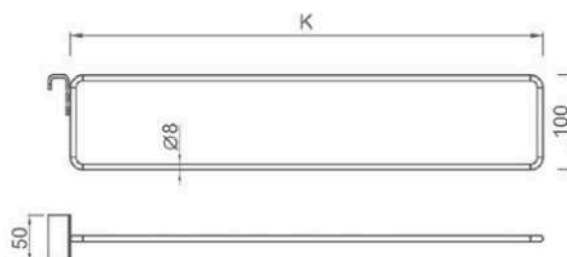
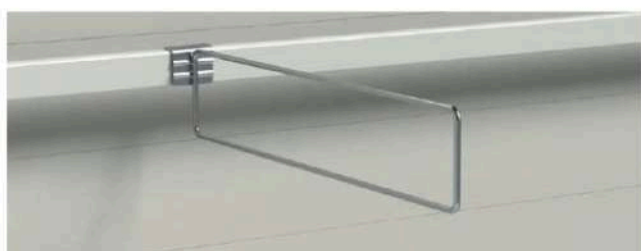

K, mm	Color	It.№	K, mm	Color	It.№	K, mm	Color	It.№
400	RAL	KI020210	500	RAL	KI020211	600	RAL	KI020261
700	RAL	KI020262	800	RAL	KI020263			

Разделитель прямоугольный на балку 15x30 | Rectangular divider for beam 15x30



K, mm	Color	It.№	K, mm	Color	It.№	K, mm	Color	It.№	K, mm	Color	It.№
400	RAL	KI020183	500	RAL	KI020184	600	RAL	KI020185	700	RAL	KI020259

Разделитель вертикальный | Vertical divider for beam 15x30



H, mm	K, mm	Color	It.№	H, mm	K, mm	Color	It.№
600	400	RAL	KI020264	800	400	RAL	KI020269
600	400	zinc	ZN020264	800	400	zinc	ZN020269
600	400	chrome	CH020264	800	400	chrome	CH020269
600	500	RAL	KI020265	800	500	RAL	KI020270
600	500	zinc	ZN020265	800	500	zinc	ZN020270
600	500	chrome	CH020265	800	500	chrome	CH020270
600	600	RAL	KI020266	800	600	RAL	KI020271
600	600	zinc	ZN020266	800	600	zinc	ZN020271
600	600	chrome	CH020266	800	600	chrome	CH020271
600	700	RAL	KI020267	800	700	RAL	KI020272
600	700	zinc	ZN020267	800	700	zinc	ZN020272
600	700	chrome	CH020267	800	700	chrome	CH020272
600	800	RAL	KI020268	800	800	RAL	KI020273
600	800	zinc	ZN020268	800	800	zinc	ZN020273
600	800	chrome	CH020268	800	800	chrome	CH020273

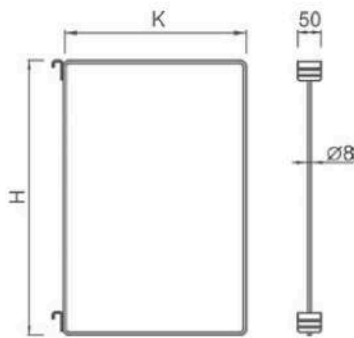

Разделитель вертикальный сеточный | Vertical wire divider for beam 15x30



H, mm	K, mm	Color	It.№	H, mm	K, mm	Color	It.№
600	400	RAL	KI020274	800	400	RAL	KI020279
600	400	zinc	ZN020274	800	400	zinc	ZN020279
600	400	chrome	CH020274	800	400	chrome	CH020279
600	500	RAL	KI020275	800	500	RAL	KI020280
600	500	zinc	ZN020275	800	500	zinc	ZN020280
600	500	chrome	CH020275	800	500	chrome	CH020280
600	600	RAL	KI020276	800	600	RAL	KI020281
600	600	zinc	ZN020276	800	600	zinc	ZN020281
600	600	chrome	CH020276	800	600	chrome	CH020281
600	700	RAL	KI020277	800	700	RAL	KI020282
600	700	zinc	ZN020277	800	700	zinc	ZN020282
600	700	chrome	CH020277	800	700	chrome	CH020282
600	800	RAL	KI020278	800	800	RAL	KI020283
600	800	zinc	ZN020278	800	800	zinc	ZN020283
600	800	chrome	CH020278	800	800	chrome	CH020283

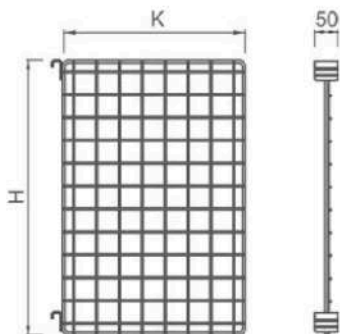

Подвеска полукруглая | Rounded hanger for beam 15x30

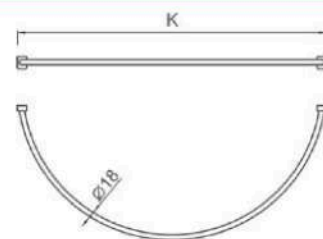
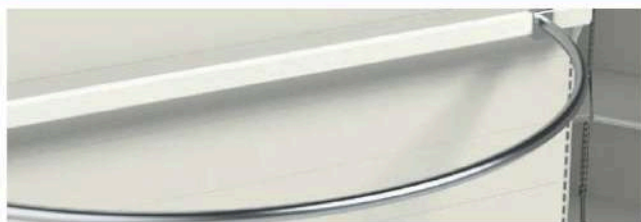

K, mm	Color	It.№	K, mm	Color	It.№	K, mm	Color	It.№	K, мм	Color	It.№
660	RAL	KI050171	1000	RAL	KI050172	1250	RAL	KI050173	1330	RAL	KI050174
660	zinc	ZN050171	1000	zinc	ZN050172	1250	zinc	ZN050173	1330	zinc	ZN050174
660	chrome	CH050171	1000	chrome	CH050172	1250	chrome	CH050173	1330	chrome	CH050174

Подвеска изогнутая | Bent hanger

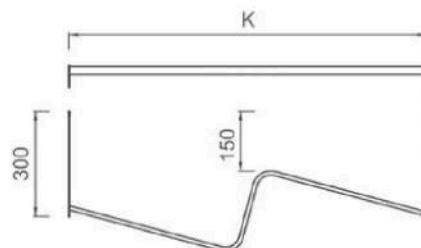

K, mm	Color	It.№	K, mm	Color	It.№	K, mm	Color	It.№	K, мм	Color	It.№
660	RAL	KI050371	1000	RAL	KI050372	1250	RAL	KI050373	1330	RAL	KI050374
660	zinc	ZN050371	1000	zinc	ZN050372	1250	zinc	ZN050373	1330	zinc	ZN050374
660	chrome	CH050371	1000	chrome	CH050372	1250	chrome	CH050373	1330	chrome	CH050374

Подвеска | Hanger

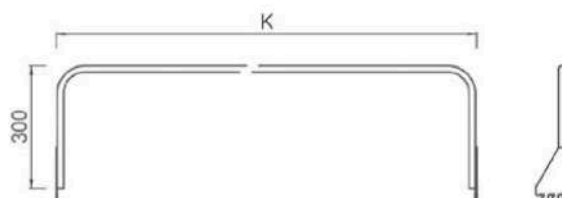

K, mm	Color	It.№	K, mm	Color	It.№	K, mm	Color	It.№	K, мм	Color	It.№
660	RAL	KI050175	1000	RAL	KI050176	1250	RAL	KI050177	1330	RAL	KI050178
660	zinc	ZN050175	1000	zinc	ZN050176	1250	zinc	ZN050177	1330	zinc	ZN050178
660	chrome	CH050175	1000	chrome	CH050176	1250	chrome	CH050177	1330	chrome	CH050178

Крюк для фена для перфорированной балки | Display for hair dryer for perforated beam

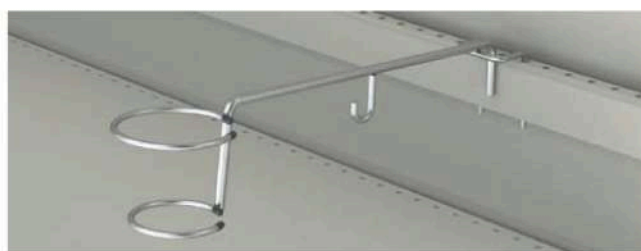

K, mm	Color	It.№
300	RAL	KI061312
300	zinc	ZN061312
300	chrome	CH061312

Крюк одинарный с ценникодержателем для перфорированной балки | Single hook with price tag

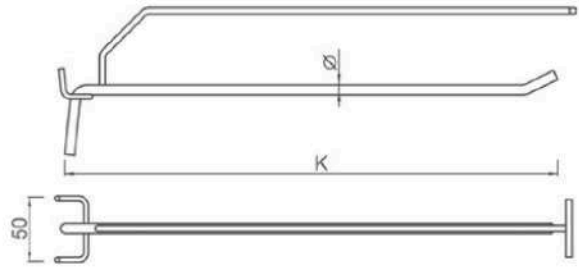
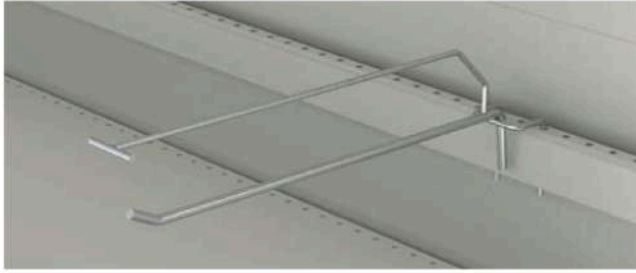

Ø, mm	K, mm	Color	It.№	K, mm	Color	It.№	K, mm	Color	It.№	K, mm	Color	It.№
5	200	RAL	KI061424	300	RAL	KI061425	400	RAL	KI061426	500	RAL	KI061427
5	200	zinc	ZN061424	300	zinc	ZN061425	400	zinc	ZN061426	500	zinc	ZN061427
5	200	chrome	CH061424	300	chrome	CH061425	400	chrome	CH061426	500	chrome	CH061427
6	200	RAL	KI061428	300	RAL	KI061429	400	RAL	KI061430	500	RAL	KI061431
6	200	zinc	ZN061428	300	zinc	ZN061429	400	zinc	ZN061430	500	zinc	ZN061431
6	200	chrome	CH061428	300	chrome	CH061429	400	chrome	CH061430	500	chrome	CH061431
8	200	RAL	KI061432	300	RAL	KI061433	400	RAL	KI061434	500	RAL	KI061435
8	200	zinc	ZN061432	300	zinc	ZN061433	400	zinc	ZN061434	500	zinc	ZN061435
8	200	chrome	CH061432	300	chrome	CH061433	400	chrome	CH061434	500	chrome	CH061435

Крюк двойной с ценникодержателем для перфорированной балки | Double hook with price tag

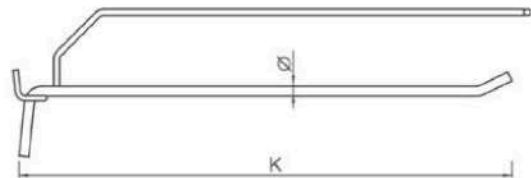
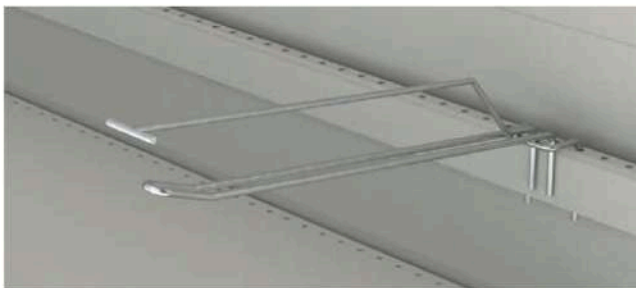

Ø, mm	K, mm	Color	It.№	K, mm	Color	It.№	K, mm	Color	It.№
5	200	RAL	KI061423	300	RAL	KI061424	400	RAL	KI061425
5	200	zinc	ZN061423	300	zinc	ZN061424	400	zinc	ZN061425
5	200	chrome	CH061423	300	chrome	CH061424	400	chrome	CH061425
6	200	RAL	KI061426	300	RAL	KI061427	400	RAL	KI061428
6	200	zinc	ZN061426	300	zinc	ZN061427	400	zinc	ZN061428
6	200	chrome	CH061426	300	chrome	CH061427	400	chrome	CH061428

Крюк для утюга для перфорированной балки | Hook for electric iron for perforated beam

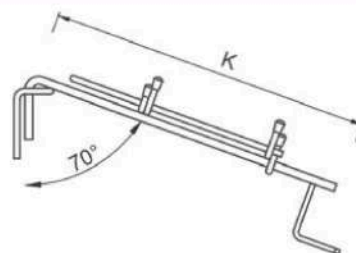
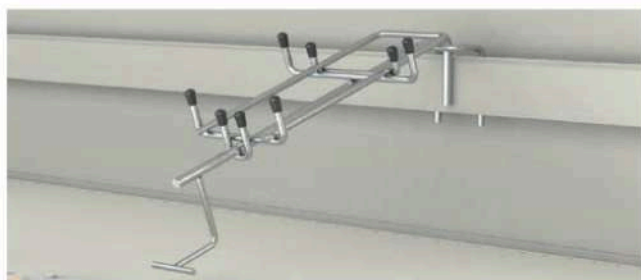

K, mm	Color	It.№
300	RAL	KI061311
300	zinc	ZN061311
300	chrome	CH061311

Разделитель перфорированной балки | Divider of perforated beam

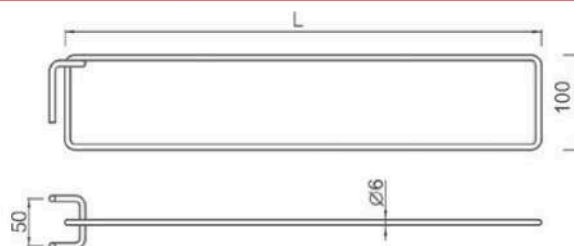
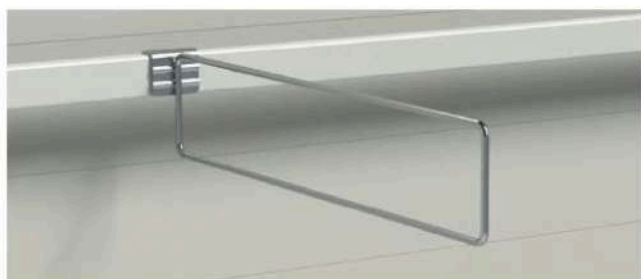

L, mm	Color	It.№	L, mm	Color	It.№
400	RAL	KI061243	500	RAL	KI061244
400	zinc	ZN061243	500	zinc	ZN061244
400	chrome	CH061243	500	chrome	CH061244

Разделитель перфорированной балки с ценникодержателем | Divider of perforated beam with price tag

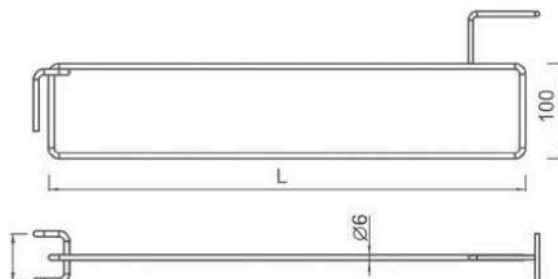
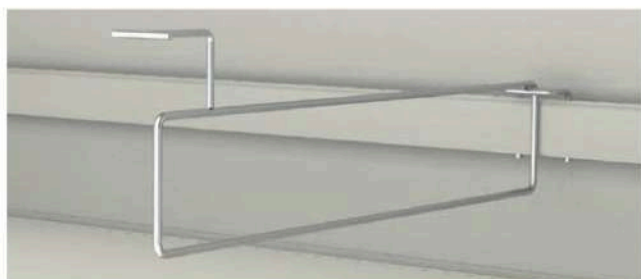

L, mm	Color	It.№	L, mm	Color	It.№
400	RAL	KI061436	500	RAL	KI061437
400	zinc	ZN061436	500	zinc	ZN061437
400	chrome	CH061436	500	chrome	CH061437

Крюк двойной на перфорацию | Double hook for perforation

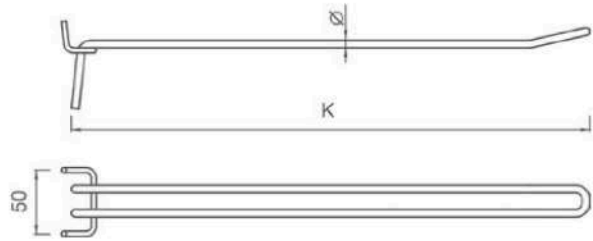

Ø, mm	K, mm	Color	It.№	K, mm	Color	It.№	K, mm	Color	It.№
5	200	RAL	KI061063	300	RAL	KI061064	400	RAL	KI061065
5	200	zinc	ZN061063	300	zinc	ZN061064	400	zinc	ZN061065
5	200	chrome	CH061063	300	chrome	CH061064	400	chrome	CH061065
6	200	RAL	KI061066	300	RAL	KI061067	400	RAL	KI061068
6	200	zinc	ZN061066	300	zinc	ZN061067	400	zinc	ZN061068
6	200	chrome	CH061066	300	chrome	CH061067	400	chrome	CH061068

Крюк двойной с ценникодержателем на перфорацию | Double hook for perforation with price tag

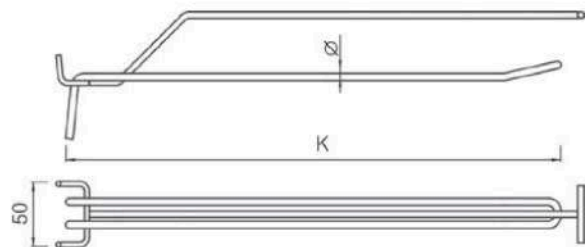
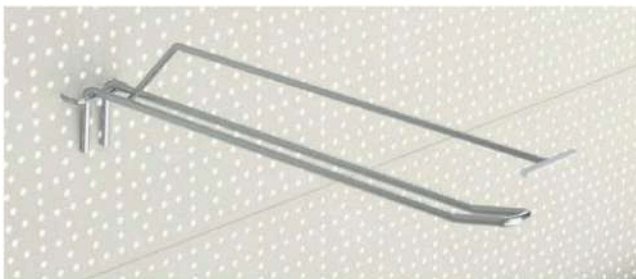

Ø, mm	K, mm	Color	It.№	K, mm	Color	It.№	K, mm	Color	It.№	K, mm	Color	It.№
5	200	RAL	KI061099	300	RAL	KI061100	400	RAL	KI061101			
5	200	zinc	ZN061099	300	zinc	ZN061100	400	zinc	ZN061101			
5	200	chrome	CH061099	300	chrome	CH061100	400	chrome	CH061101			
6	200	RAL	KI061102	300	RAL	KI061103	400	RAL	KI061104	500	RAL	KI061298
6	200	zinc	ZN061102	300	zinc	ZN061103	400	zinc	ZN061104	500	zinc	ZN061298
6	200	chrome	CH061102	300	chrome	CH061103	400	chrome	CH061104	500	chrome	CH061298

Крюк одинарный на перфорацию | Single hook for perforation

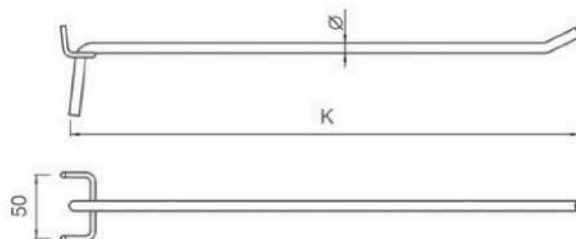
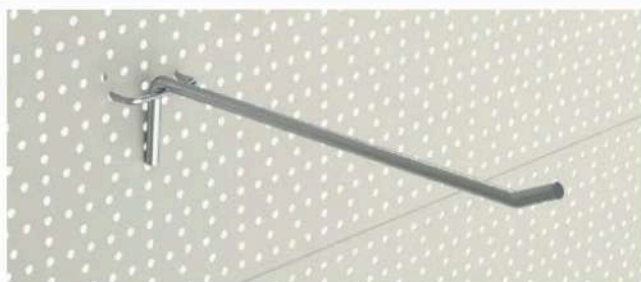

Ø, mm	K, mm	Color	It.№	K, mm	Color	It.№	K, mm	Color	It.№	K, mm	Color	It.№
5	50	RAL	KI061165	100	RAL	KI061166	150	RAL	KI061167	200	RAL	KI061168
5	50	zinc	ZN061165	100	zinc	ZN061166	150	zinc	ZN061167	200	zinc	ZN061168
5	50	chrome	CH061165	100	chrome	CH061166	150	chrome	CH061167	200	chrome	CH061168
5	250	RAL	KI061170	300	RAL	KI061171	350	RAL	KI061173	400	RAL	KI061174
5	250	zinc	ZN061170	300	zinc	ZN061171	350	zinc	ZN061173	400	zinc	ZN061174
5	250	chrome	CH061170	300	chrome	CH061171	350	chrome	CH061173	400	chrome	CH061174
6	200	RAL	KI061081	300	RAL	KI061082	400	RAL	KI061083	500	RAL	KI061176
6	200	zinc	ZN061081	300	zinc	ZN061082	400	zinc	ZN061083	500	zinc	ZN061176
6	200	chrome	CH061081	300	chrome	CH061082	400	chrome	CH061083	500	chrome	CH061176
8	200	RAL	KI061084	300	RAL	KI061085	400	RAL	KI061086	500	RAL	KI061087
8	200	zinc	ZN061084	300	zinc	ZN061085	400	zinc	ZN061086	500	zinc	ZN061087
8	200	chrome	CH061084	300	chrome	CH061085	400	chrome	CH061086	500	chrome	CH061087

Крюк одинарный с ценникодержателем на перфорацию | Single hook for perforation with price tag

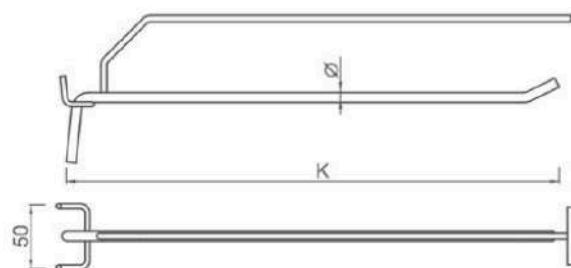

Ø, mm	K, mm	Color	It.№	K, mm	Color	It.№	K, mm	Color	It.№
6	200	RAL	KI061090	300	RAL	KI061091	400	RAL	KI061092
6	200	zinc	ZN061090	300	zinc	ZN061091	400	zinc	ZN061092
6	200	chrome	CH061090	300	chrome	CH061091	400	chrome	CH061092
8	300	RAL	KI061093	400	RAL	KI061094	500	RAL	KI061095
8	300	zinc	ZN061093	400	zinc	ZN061094	500	zinc	ZN061095
8	300	chrome	CH061093	400	chrome	CH061094	500	chrome	CH061095

Вешалка для одежды с ценникомодержателем для эконом панелей | Inclined tubular hanger with p.tag

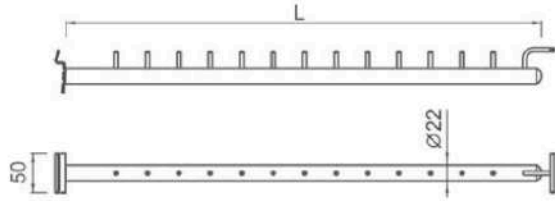
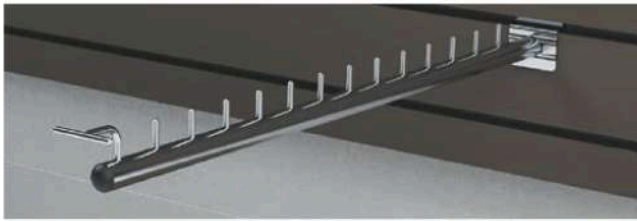

L, mm	Color	It.№	L, mm	Color	It.№	L, mm	Color	It.№	L, mm	Color	It.№
300	RAL	KI061199	400	RAL	KI061200	500	RAL	KI061201	600	RAL	KI061202
300	zinc	ZN061199	400	zinc	ZN061200	500	zinc	ZN061201	600	zinc	ZN061202
300	chrome	CH061199	400	chrome	CH061200	500	chrome	CH061201	600	chrome	CH061202

Вешалка для одежды для эконом панелей | Inclined tubular hanger for grooved back panel

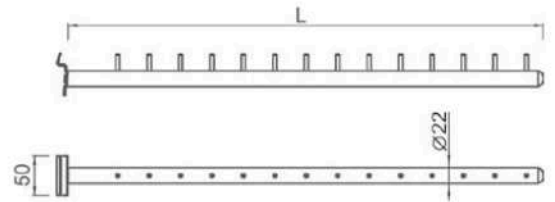
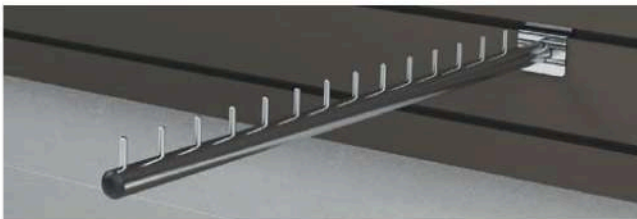

L, mm	Color	It.№	L, mm	Color	It.№	L, mm	Color	It.№	L, mm	Color	It.№
300	RAL	KI061203	400	RAL	KI061204	500	RAL	KI061205	600	RAL	KI061206
300	zinc	ZN061203	400	zinc	ZN061204	500	zinc	ZN061205	600	zinc	ZN061206
300	chrome	CH061203	400	chrome	CH061204	500	chrome	CH061205	600	chrome	CH061206

Вешалка для одежды изогнутая с наклоном и ценникомодержателем для эконом панелей

Inclined tubular hanger for clothes with price tag for grooved back panel

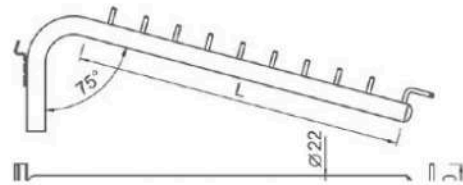

L, mm	Color	It.№	L, mm	Color	It.№	L, mm	Color	It.№	L, mm	Color	It.№
300	RAL	KI061367	400	RAL	KI061368	500	RAL	KI061369	600	RAL	KI061370
300	zinc	ZN061367	400	zinc	ZN061368	500	zinc	ZN061369	600	zinc	ZN061370
300	chrome	CH061367	400	chrome	CH061368	500	chrome	CH061369	600	chrome	CH061370

Вешалка для одежды изогнутая с наклоном для эконом панелей

Inclined tubular hanger for clothes for grooved back panel

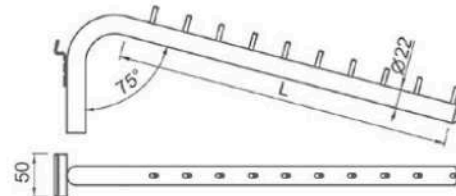

L, mm	Color	It.№	L, mm	Color	It.№	L, mm	Color	It.№	L, mm	Color	It.№
300	RAL	KI061371	400	RAL	KI061372	500	RAL	KI061373	600	RAL	KI061374
300	zinc	ZN061371	400	zinc	ZN061372	500	zinc	ZN061373	600	zinc	ZN061374
300	chrome	CH061371	400	chrome	CH061372	500	chrome	CH061373	600	chrome	CH061374

Крюк двойной с ценникодержателем для эконом панелей | Double hook with price tag for grooved panel

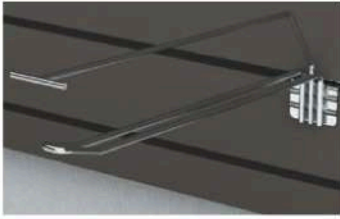

Ø, mm	K, mm	Color	It.№	K, mm	Color	It.№	K, mm	Color	It.№
5	200	RAL	KI061111	300	RAL	KI061112	400	RAL	KI061113
5	200	zinc	ZN061111	300	zinc	ZN061112	400	zinc	ZN061113
5	200	chrome	CH061111	300	chrome	CH061112	400	chrome	CH061113
6	200	RAL	KI061114	300	RAL	KI061115	400	RAL	KI061116
6	200	zinc	ZN061114	300	zinc	ZN061115	400	zinc	ZN061116
6	200	chrome	CH061114	300	chrome	CH061115	400	chrome	CH061116

Крюк двойной для эконом панелей | Double hook for grooved back panel

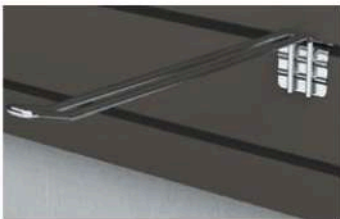

Ø, mm	K, mm	Color	It.№	K, mm	Color	It.№	K, mm	Color	It.№
5	200	RAL	KI061105	300	RAL	KI061106	400	RAL	KI061107
5	200	zinc	ZN061105	300	zinc	ZN061106	400	zinc	ZN061107
5	200	chrome	CH061105	300	chrome	CH061106	400	chrome	CH061107
6	200	RAL	KI061108	300	RAL	KI061109	400	RAL	KI061110
6	200	zinc	ZN061108	300	zinc	ZN061109	400	zinc	ZN061110
6	200	chrome	CH061108	300	chrome	CH061109	400	chrome	CH061110

Крюк одинарный с ценникодержателем для эконом панелей | Single hook with price tag for grooved panel

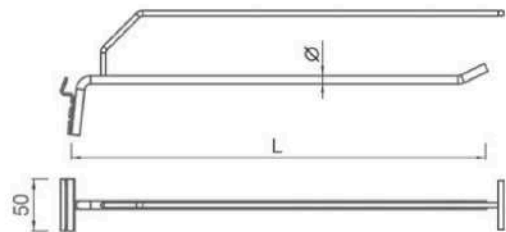
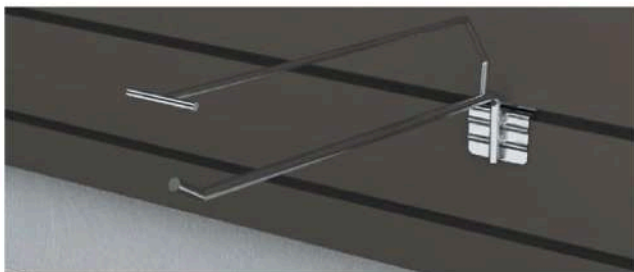

Ø, mm	K, mm	Color	It.№	K, mm	Color	It.№	K, mm	Color	It.№	K, mm	Color	It.№
6	200	RAL	KI061123	300	RAL	KI061124	400	RAL	KI061125			
6	200	zinc	ZN061123	300	zinc	ZN061124	400	zinc	ZN061125			
6	200	chrome	CH061123	300	chrome	CH061124	400	chrome	CH061125			
8	200	RAL	KI061126	300	RAL	KI061127	400	RAL	KI061128	500	RAL	KI061129
8	200	zinc	ZN061126	300	zinc	ZN061127	400	zinc	ZN061128	500	zinc	ZN061129
8	200	chrome	CH061126	300	chrome	CH061127	400	chrome	CH061128	500	chrome	CH061129
10	500	RAL	KI061130	600	RAL	KI061131						
10	500	zinc	ZN061130	600	zinc	ZN061131						
10	500	chrome	CH061130	600	chrome	CH061131						

Крюк одинарный для эконом панелей | Single hook for grooved back panel

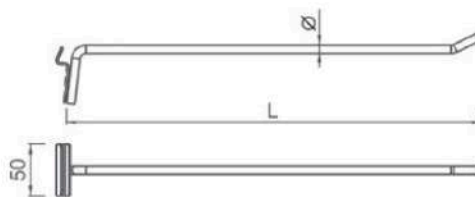
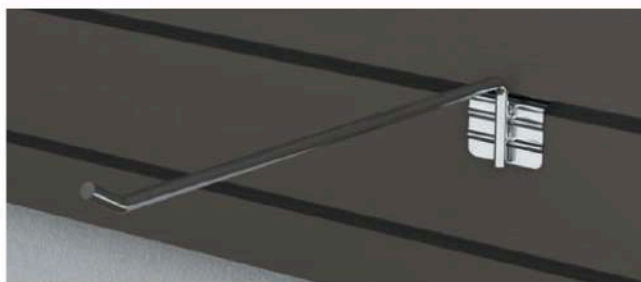

Ø, mm	K, mm	Color	It.№	K, mm	Color	It.№	K, mm	Color	It.№	K, mm	Color	It.№
6	200	RAL	KI061156	300	RAL	KI061157	400	RAL	KI061158			
6	200	zinc	ZN061156	300	zinc	ZN061157	400	zinc	ZN061158			
6	200	chrome	CH061156	300	chrome	CH061157	400	chrome	CH061158			
8	200	RAL	KI061159	300	RAL	KI061160	400	RAL	KI061161	500	RAL	KI061162
8	200	zinc	ZN061159	300	zinc	ZN061160	400	zinc	ZN061161	500	zinc	ZN061162
8	200	chrome	CH061159	300	chrome	CH061160	400	chrome	CH061161	500	chrome	CH061162
10	500	RAL	KI061163	600	RAL	KI061164						
10	500	zinc	ZN061163	600	zinc	ZN061164						
10	500	chrome	CH061163	600	chrome	CH061164						

Крюк для бра для эконом панелей | Hook for sconce for grooved back panel

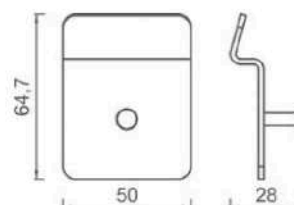

Color	It.№
RAL	KI061305

Крюк для скейтборда для эконом панелей | Hook for skateboard for grooved back panel

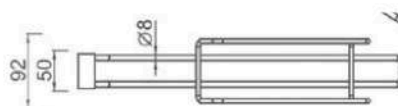
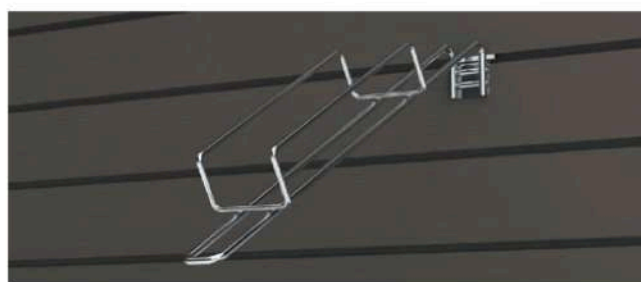

L, mm	Color	It.№	L, mm	Color	It.№
400	RAL	KI061275	500	RAL	KI061281
400	zinc	ZN061275	500	zinc	ZN061281
400	chrome	CH061275	500	chrome	CH061281

Крюк для утюга с ценникодержателем для эконом панелей | Hook for iron for back panel with p.tag



L, mm	Color	It.№	L, mm	Color	It.№	L, mm	Color	It.№
300	RAL	KI061255	350	RAL	KI061256	450	RAL	KI061257
300	zinc	ZN061255	350	zinc	ZN061256	450	zinc	ZN061257
300	chrome	CH061255	350	chrome	CH061256	450	chrome	CH061257

Подставка для тарелок с передвижной стенкой для эконом панелей | Support for plates for grooved back panel

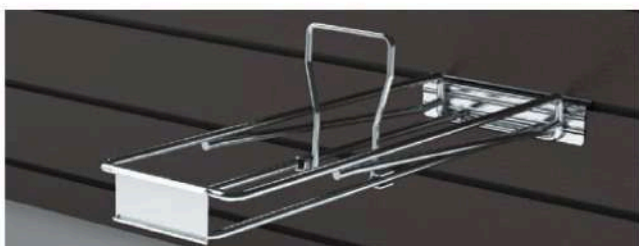

L, mm	Color	It.№	L, mm	Color	It.№	L, mm	Color	It.№
400	RAL	KI061258	500	RAL	KI061259	600	RAL	KI061260
400	zinc	ZN061258	500	zinc	ZN061259	600	zinc	ZN061260
400	chrome	CH061258	500	chrome	CH061259	600	chrome	CH061260

Держатель для крышки унитаза | Holder for water-closed lid

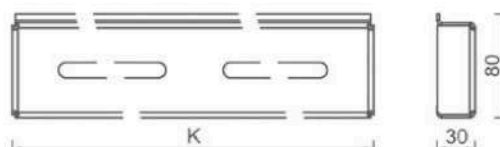
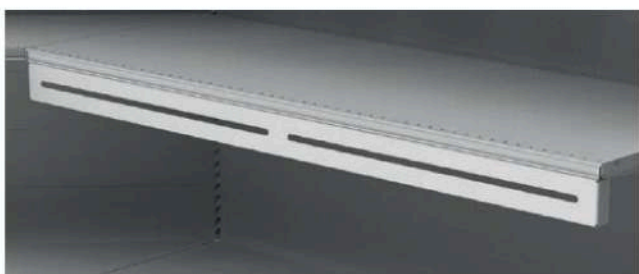

K, mm	Color	It.№	K, mm	Color	It.№	K, mm	Color	It.№
1000	RAL	KI061340	1250	RAL	KI061341	1330	RAL	KI061342

Экспозитор дверных ручек | Panel for door handles and door knobs

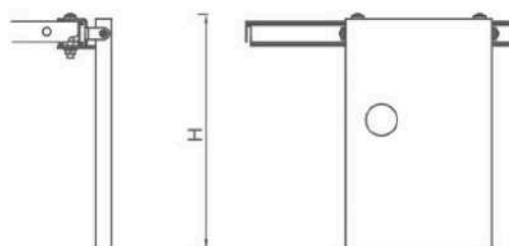
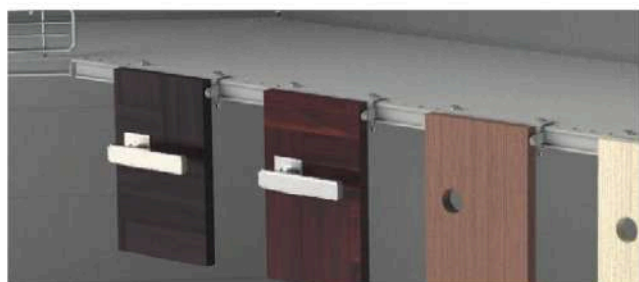

Color	It.№
RAL	KI240021

Дверка сеточная навесная | Hook up mesh door

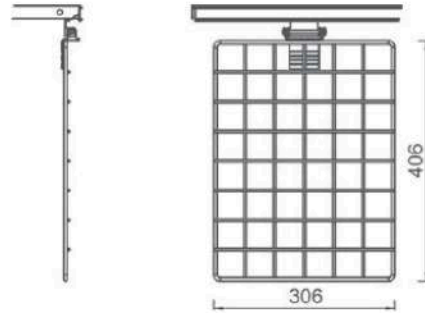
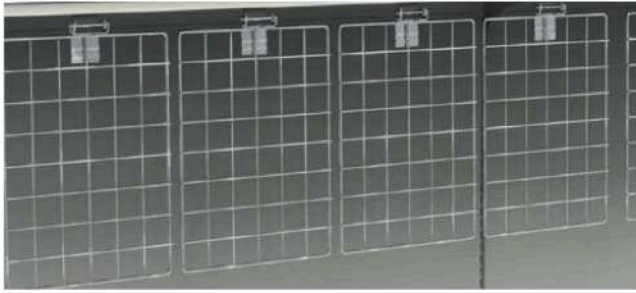

Color | It.№
RAL | KI240071

Ценникодержатель навесной | Hook up label holder

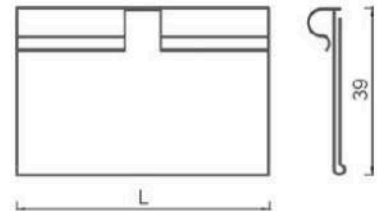

Color | It.№
RAL | KI040393

Ценникодержатель пластиковый | Plastic label holder



L, mm	It.№
660	KI040158
1000	KI040159
1250	KI040160
1330	KI040161

Ценникодержатель пластиковый для полукруглой торцевой полки | Plastic label for rounded frontal shelf

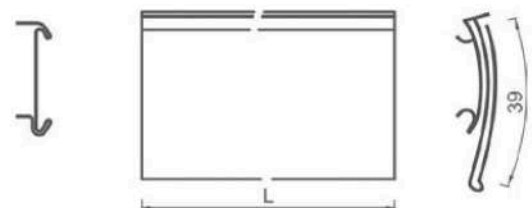

L, mm	It.№
1000	KI040174
1250	KI040397

Ценникодержатель пластиковый для сеточных стеллажей | Plastic label holder for mesh racks

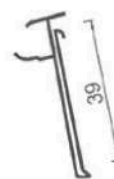
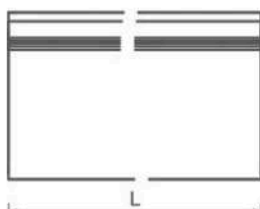
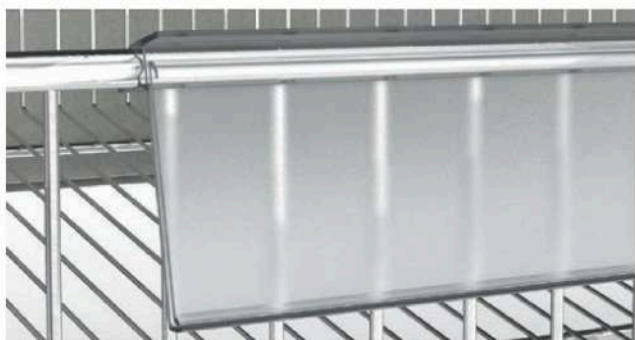

L, mm	It.№
660	KI040162
1000	KI040163
1250	KI040164
1330	KI040165

Ценникодержатель пластиковый на корзину | Plastic holder for price label used on basket

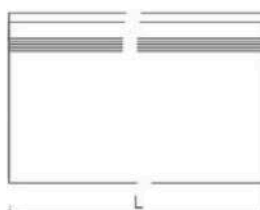
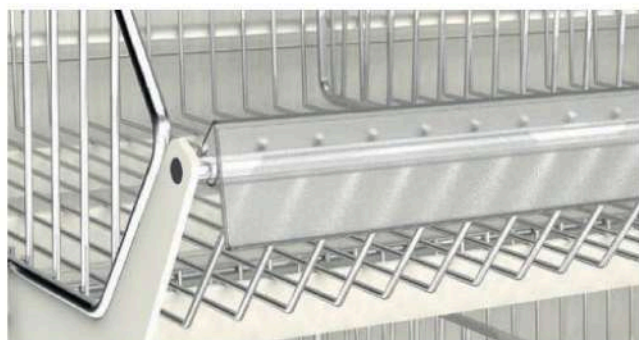

L, mm	It.№
1000	KI040324
1250	KI040186
1330	KI040187

